

CABLE RANGER 3.0

CABLE RANGER 3.1

FIBER-COAXIAL DOCSIS ANALYZER



-O MI2177 -



SAFETY NOTES

Read the user's manual before using the equipment, mainly "**SAFETY RULES**" paragraph.

The symbol  on the equipment means "**SEE USER'S MANUAL**". In this manual may also appear as a Caution or Warning symbol.

WARNING AND CAUTION statements may appear in this manual to avoid injury hazard or damage to this product or other property.

USER'S MANUAL ELECTRONIC VERSION

You can access instantly to any chapter by clicking on the title of the chapter in the table of contents.

lick on the arrow  at the top right page to return to the table of contents.

USER'S MANUAL VERSION

Manual Version	Web Published Date	Firmware Version
F2.0	November 2022	10.1.44

- Please update your equipment to the latest firmware version available.
- This user's manual describes operation for models **CABLE RANGER 3.0** and **CABLE RANGER 3.1**. Differences between them are specified by an asterisk(*) and in certain sections explicitly.















WHAT'S NEW on manual F2.0

- Update: Change of name from **CABLE RANGER +** to **CABLE RANGER 3.0**.
- Update: Specifications updated.
- Improvement: Video-tutorials inserted along the manual (direct hyperlink/QR code).
- New: New option to adjust screen brightness.
- New: Option to import standard channel plans.
- Others: Other minor updates and improvements.

SAFETY RULES

- * The safety could not be assured if the instructions for use are not closely followed.
- * Use this equipment connected only to systems with their negative of measurement connected to ground potential.
- * The AL-103 external DC charger is a Class I equipment, for safety reasons plug it to a supply line with the corresponding ground terminal.
- * This equipment can be used in Overvoltage Category I installations and Pollution Degree 2 environments.
- * External DC charger can be used in Overvoltage Category II, installation and Pollution Degree 1 environments.
- * When using some of the following accessories use only the specified ones to ensure safety:
 - Rechargeable battery
 - External DC charger
 - Car lighter charger cable
 - Power cord
- * Observe all specified ratings both of supply and measurement.
- * Remember that voltages higher than 70 V DC or 33 V AC rms are dangerous.
- * Use this instrument under the specified environmental conditions.
- * When using the power adaptor, the negative of measurement is at ground potential.
- * Do not obstruct the ventilation system of the instrument.
- * Use for the signal inputs/outputs, specially when working with high levels, appropriate low radiation cables.
- * Follow the cleaning instructions described in the Maintenance paragraph.

SAFETY SYMBOLS

 DIRECT CURRENT	 ON (Supply)
 ALTERNATING CURRENT	 OFF (Supply)
 DIRECT AND ALTERNATING	 DOUBLE INSULATION (Class II protection)
 GROUND TERMINAL	 CAUTION (Risk of electric shock)
 PROTECTIVE CONDUCTOR	 CAUTION REFER TO MANUAL
 FRAME TERMINAL	 FUSE
 EQUIPOTENTIALITY	 EQUIPMENT OR COMPONENT TO BE RECYCLED

DESCRIPTIVE EXAMPLES OF OVER VOLTAGE CATEGORIES

- * **Cat I**: Low voltage installations isolated from the mains.
- * **Cat II**: Portable domestic installations.
- * **Cat III**: Fixed domestic installations.
- * **Cat IV**: Industrial installations.

CAUTION: The battery used can present danger of fire or chemical burn if it is severely mistreat. Do not disassembly, cremate or heat the battery above 100 °C under no circumstances.

TABLE OF CONTENTS

1. INTRODUCTION	1
1.1. Description	1
2. SETTING UP	4
2.1. Package Content	4
2.2. Power	4
2.3. Equipment Details	7
2.4. Switching On / Off	9
2.5. Icons Table	10
2.6. Icons Table	11
2.7. Controls	11
2.8. General Settings	12
2.9. Firmware Update	13
3. MEASUREMENT	14
3.1. Spectrum Analyzer (cable & FO)	14
3.2. Scan (cable & FO)	17
3.3. Tilt (cable & FO)	20
3.4. SATELLITE (cable & FO)	23
3.5. CABLE MODEM	26
3.6. External CM / Upstream Spectrum (cable)	42
3.7. Upstream Test (cable)	44
3.8. Input Voltage (cable)	46
3.9. Optical Power Meter (FO)	47
4. TOOLS	50
4.1. Edit Channel Plan	50
4.2. Demodulator	57
4.3. Analog Video Carrier / HUM	59
4.4. Screenshot	60
4.5. Datalogger	62
5. WEBCONTROL	64
5.1. Introduction	64
5.2. Settings and Remote Access	64
5.3. File Management	66
6. SPECIFICATIONS	71
7. MAINTENANCE	81
7.1. Instructions for Returning by Mail	81
7.2. Considerations about the TFT Screen	81
7.3. Cleaning Recommendations	81



FIBER-COAXIAL DOCSIS ANALYZER

CABLE RANGER

1 INTRODUCTION

1.1 Description

The **CABLE RANGER** is the latest introduction in our CATV analyzer product range. It is an hybrid analyzer (for both fibre optics and coaxial cable) for the installation, configuration and maintenance of interactive video and data services at high speed over TV networks based on the DOCSIS standard. It also allows the qualification of VoIP and IPTV services.

The **CABLE RANGER** includes an optical measurement input allowing field technicians not only to perform optical power measurements but also to do all the RFoG related RF measurements thanks to the built-in optical to RF converter.

The **CABLE RANGER** incorporates the most advanced functions in accordance with the updates to the latest version of the DOCSIS 3 protocol, including channel bonding technology, which are the latest technology implemented by operators in the cable data networks.

The **CABLE RANGER** has all the functions necessary for an easy installation of any service offered by cable. In addition, its intuitive menu, its adjusted weight and strength, makes it ideal for fieldwork. The **CABLE RANGER** features a 7" professional grade resistive type touch-screen with excellent brightness and superior image sharpness that can also be used wearing gloves. The instrument is powered by an internal rechargeable battery.

In the design of the **CABLE RANGER** it has dedicated particular attention on making a practical and precise instrument, as easy to use. The touch interface allows direct access to different modes of operation and once there, it is easy to modify any parameter of the measurement.

All this makes the **CABLE RANGER** in a magnificent tool for installing and maintaining HFC (Hybrid Fibber Cable) / CATV, analog and digital systems. Being also very useful for testing DOCSIS data transmission systems.

In addition, the instrument provides Ethernet, USB and mini-USB port slots to connect to external devices, to download data and to update firmware. It also has an internal software that runs on any web browser and it allows you to connect to the meter to create or edit channel plans and manage files.

Here are some of the most important functions in the **CABLE RANGER**. Spectrum Analyzer, Scan, TILT, Satellite and DOCSIS Analyzer functions are performed through coaxial input and are also available for optical fiber thanks to the optical-electric converter (with the exception of Cable Modem emulation).



The main difference between **CABLE RANGER 3.1** and **CABLE RANGER 3.0** is that the 3.1 model has an OFDM demodulator that allows you to demodulate DOCSIS 3.1 channels. These channels are made of thousands of narrow bandwidth subcarriers.



Figure 1.

The **Spectrum Analyzer** function provides an analysis of the full band and allows changing the reference level and the span among others.

The **Scan** function shows the level of all active channels in the channel plan through a bar chart.

The **TILT** function measures the tilt in dB obtained from the difference in level between four carriers. It is useful for equalizing the line.

The **Satellite** function performs an analysis of satellite channels (between 950 and 2150 MHz) and shows their power. When a channel is demodulated it shows MER, BER and constellation. If necessary, it also allows you to activate the power for LNB to measure satellite signal.

The **DOCSIS Analyzer** measures and shows downstream, upstream and constellation. It also can emulate the Cable Modem using the internal Cable Modem. The internal cable modem can be registered into the network and it shows some information about it and also using the tools VoIp, Ping and Speed.

The **External Cable Modem** function connects the equipment to an external cable modem. It extracts a sample of the Upstream signal displaying its spectrum on screen.

The **Upstream test** function creates a test signal that allows you to analyze and equalize the transmission band (fix mode or sweep mode).



The **Voltage Input** function automatically identifies the type of voltage (continuous or alternating) at the input, the voltage and displays the output current.

The **Optical Power Meter** function measures the optical power and other RFoG (Radiofrequency-over-Glass) measurements.

In addition, it includes other tools such as datalogger, screenshot, channel plan editor, etc.

In short, implementation of all these functions into an light instrument, ergonomic design and robust, makes the **CABLE RANGER** into a productive and efficient fieldwork tool for the installer.



[Introducing the CABLE RANGER](#)

S
C
A
N





2 SETTING UP

2.1 Package Content

Check that your package contains the following elements:

- **CABLE RANGER** Analyser.
- External DC charger.
- Power cord for external DC charger
- "F" / f - BNC / f Adapter.
- Support belt.
- Carrying bag.
- Transport suitcase.
- Quick Start Guide.

NOTE: Keep the original packaging, since it is specially designed to protect the equipment. You may need it in the future to send the analyser to be calibrated.

2.2 Power

The **CABLE RANGER** is powered by a 7.2 V built-in rechargeable Li-Ion battery of high quality and long operation time. This equipment can operate on battery or connected to the mains using a DC adapter. An adapter is also supplied to use with the power connector car (cigarette lighter).

2.2.1 First Charge

The equipment comes with the battery half charged. Depending on the time elapsed from first charge and environmental conditions may have lost some of the charge. You should check the battery level. It is advisable a first full charge.



2.2.2 Charging the Battery

Connect the DC power adapter to the equipment through the power connector on the left side panel (see figure).



Figure 2.

Then connect the DC power adapter to the mains via the mains cord. Ensure that your mains voltage is compatible with the adapter voltage.

For a fast charging of the battery is necessary to switch off the equipment.

If the equipment is ON, the battery charging will be slower, depending on the type of work you are doing. When connecting the equipment to the mains the mains connected symbol  appears inside the battery icon.

The CHARGER led indicator shows the battery status:

- **Red:** Battery charging.
- **Off:** Battery full charge.

When switching on the equipment, the battery voltage is checked. If the tension is too weak to start, the equipment does not start up. In this case please charge the battery immediately.

2.2.3 Charge / Discharge times

Average charging time with the equipment off (fast charge):

- 3 hours to achieve an 80% charge.
- 5 hours to achieve an 100% charge.



With the equipment on (slow charge):

- 5 hours to achieve an 80% charge.
- 8 hours to achieve a 100% charge.

Average discharge time:

- With the battery at full charge the average battery time is 3 hours.
- With the battery at 80% charge the average battery time is 2 hours.

2.2.4 Usage Tips

The battery is losing storage capacity as you go through its life. Contact your **PROMAX** distributor when necessary to replace the battery.

To prolong battery life the user should follow these tips:

- In case of providing a long inactivity period of the equipment it is advisable to make every 3 months a charge / discharge cycle and a subsequent partial charge (40% aprox.).
- It is advisable to keep it in a cool place and away from heat.
- You should avoid keeping the battery for a long period of time at full load or fully discharged.
- There is not necessary to wait to fully discharge before a charge because these batteries have no memory effect.



2.3 Equipment Details



Figure 3. Front View.

Main Menu

S
C
A
N

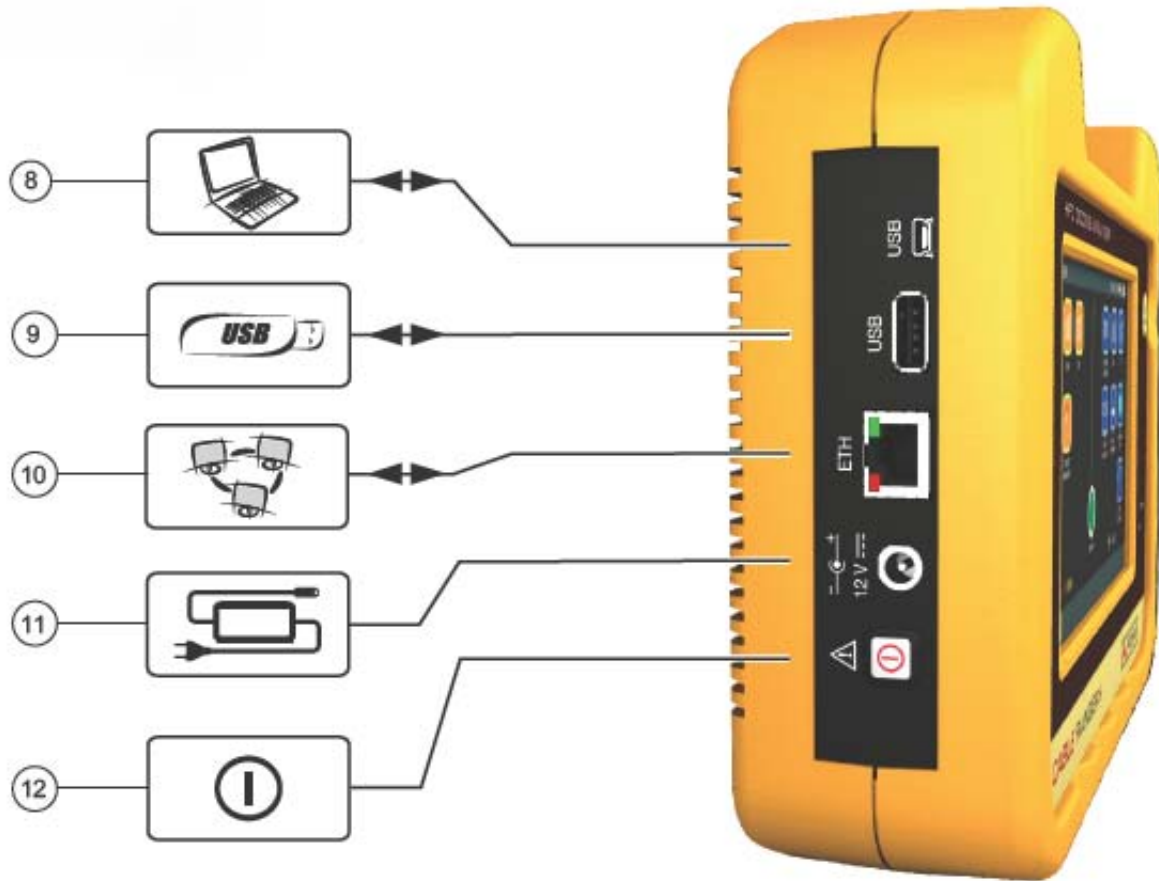

- ⑧ **Mini-USB** connector for PC
- ⑨ **USB** connector for flashdrive device
- ⑩ **Ethernet** connector for network (WebControl)
- ⑪ **12 V DC** power input connector
- ⑫ **ON / OFF** button

Figure 4. Side View.

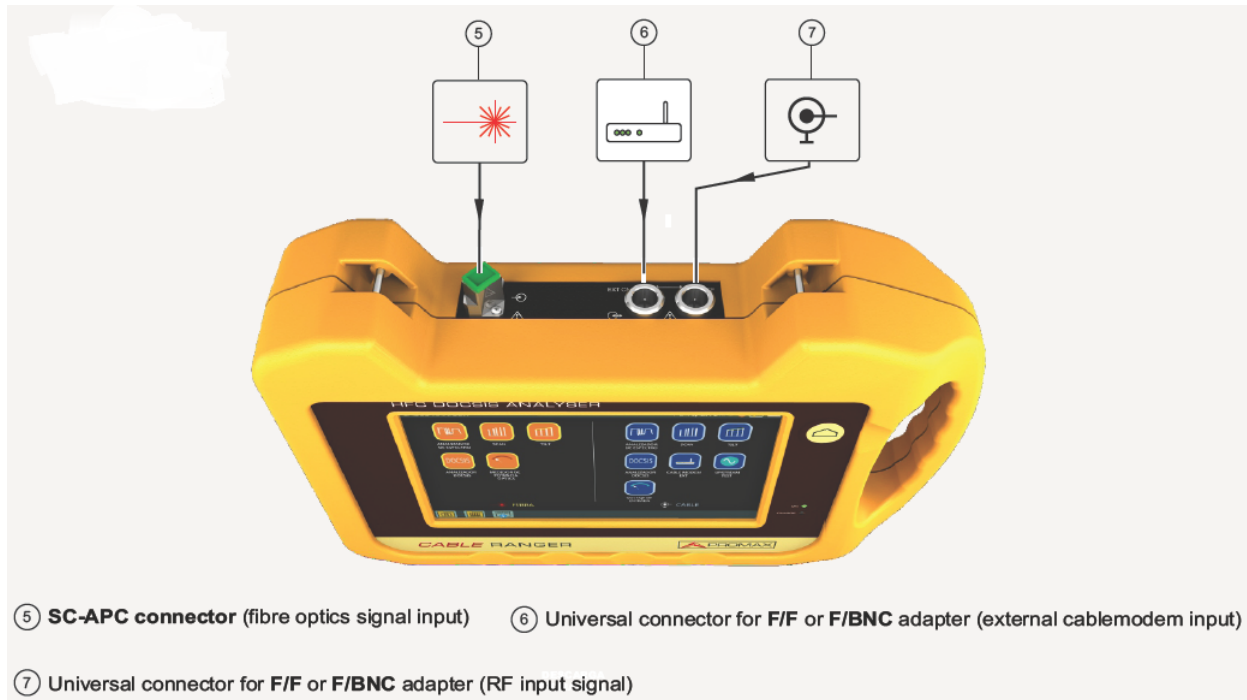



Figure 5. Top View.

2.4 Switching On / Off

► Switching On:

- 1 Press the on/off button located on the side of the equipment.
- 2 The boot screen appears. After the system load, the last screen before shutdown appears.

► Switching Off:

- 1 There are two options:
 - **Option 1:** Press the on/off* button located on the side of the equipment. A gray screen with a red power off icon  will appear. Click on this icon to turn off the equipment or outside the icon to cancel power off.
 - **Option 2:** Press on the menu icon  located at the screen upper right corner. Next press on the power off icon at the bottom right corner. A gray

*. In case of crashing, press and hold on/off button until it turns off.



screen with a red power off icon  will appear. Click on this icon to turn off the equipment or outside the icon to cancel power off.

- 2** The equipment keeps its last status which is recovered when power on.

2.5 Icons Table

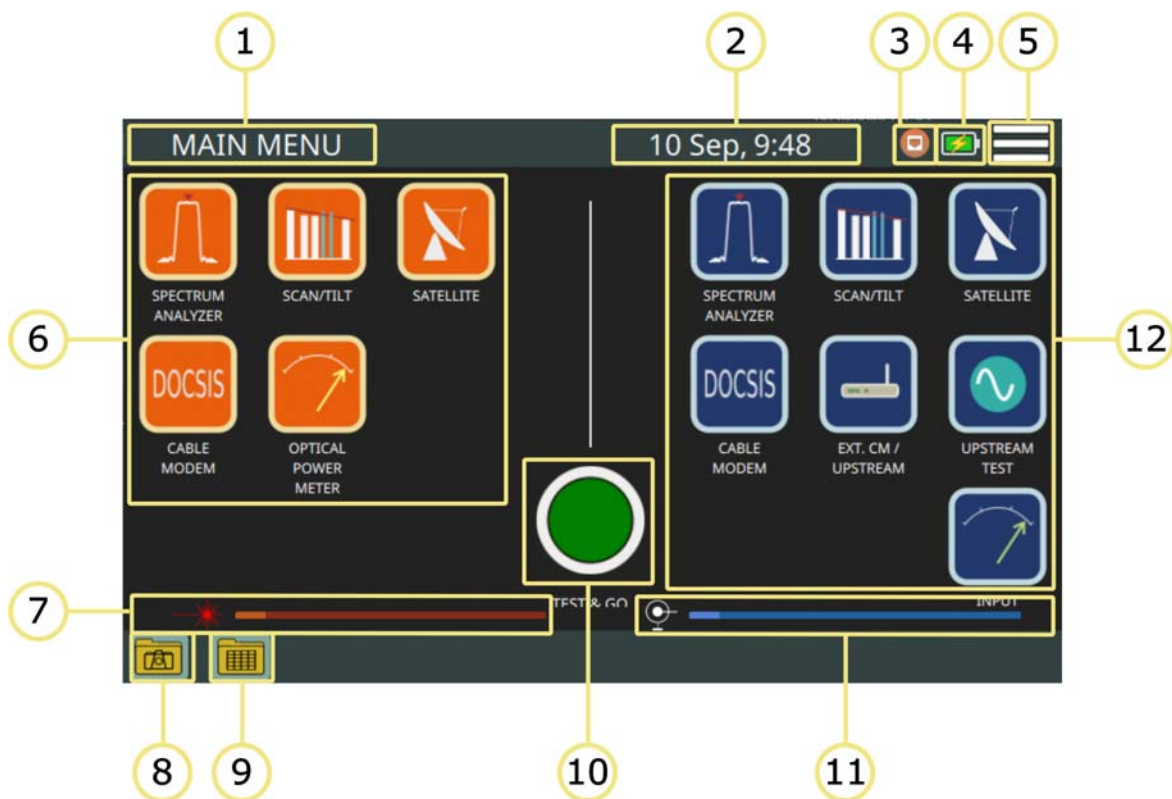

Figure 6. Main Screen

- 1** Main menu.
- 2** Date and hour.
- 3** Indicative icon: Connected to ethernet network.
- 4** Indicative icon: Charging.
- 5** Access to General Settings.
- 6** Access to measurement options for fibre optics.
- 7** Energy power for optical.
- 8** Access to photo gallery.
- 9** Access to datalogger library.



- 10** Access to datalogger (test&go).
- 11** Power energy for RF.
- 12** Access to measurement options for RF.

2.6 Icons Table

On the screen it may appear some icons, which give extra information about the meter status or functions.

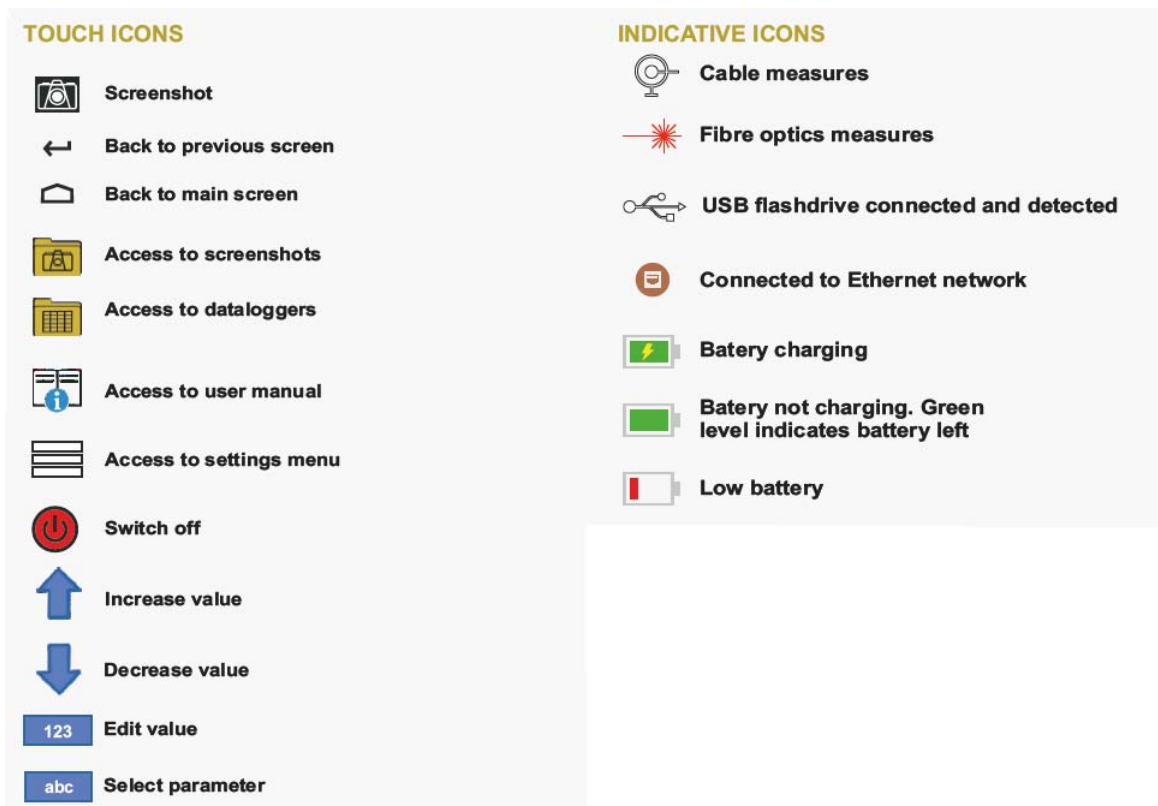

Figure 7.

2.7 Controls

The equipment can be fully operated using the touch panel..



These actions can be done through the touch panel:

- Menu Selection.
- Frequency or channel selection.
- Frequency or channel scroll.
- Reference level scroll.
- SPAN selection.
- Virtual keyboard writing (numerical and alphabetical).

2.8 General Settings

From the Home screen, clicking on the menu icon  you Access General Settings:

- **Language:** It allows you to select a language among English, Spanish, French or German.
- **Date:** It allows you to select date format (ddmmaa/mmddaa) and set date.
- **Time:** It allows you to select time format (12/24) and set time.
- **Audio:** It allows you to set sound level and enable or disable beep.
- **Auto power off:** It allows you to enable/disable the auto power-off. It switches off the meter after 5 minutes with no interaction.
- **Display:** It allows you to adjust screen brightness.
- **Equipment information:** It shows serial number, software version and other technical data.
- **Ethernet Configuration:** It allows you to select type of connection (manual/DHCP/Bridge) and network data (IP, Netmask, Gateway, DNS1, DNS2).
- **Test&Go Configuration:** It allows you to select what type of measurement are taken when using the test&go datalogger.
- **Web Server:** It shows the IP to access the webServer application.



2.9 **Firmware Update**

Keep your device up to date for the latest improvements and features.

Follow us on social networks (twitter, Facebook, linkedin) to get information about updates and latest news.

To update your meter firmware please contact PROMAX:

<https://www.promaxelectronics.com/ing/contact-promax/>



3 MEASUREMENT

3.1 Spectrum Analyzer (cable & FO)

► Description



The **SPECTRUM ANALYZER** function shows on screen the spectrum of the signal received through the input connector.

This function shows signals in frequency band so user can detect any problem and also measures level and demodulates signal.

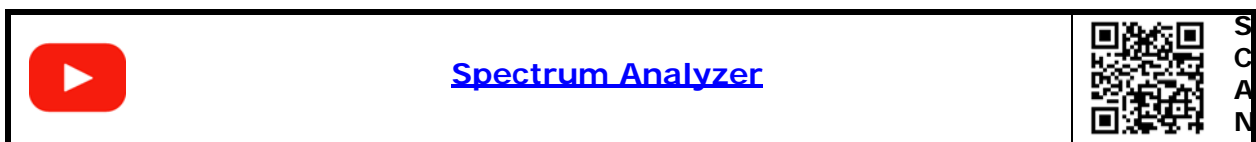
User can select span and reference level by selecting a frequency or channel. He also can select detector type (maximum / minimum peak), measurement units and other parameters.



► Operation

- 1 Connect signal to the input connector:
 - **Cable:** universal connector for F/F or F/BNC adapter.
 - **Fiber Optics:** SC-APC connector.
- 2 Access the home screen by pressing the HOME key .
- 3 Select **SPECTRUM ANALYZER** function according to input signal (cable or fiber). Press function on the left side of the screen for **FIBER OPTICS** or on the right side for **CABLE**.
- 4 **SPECTRUM ANALYZER** function opens.
- 5 Select channel or frequency.
- 6 To obtain more information about the signal press on **SYSTEM:**
 - **CHANNEL tuning:** By default it demodulates by using the standard which is defined on the channel plan for the selected channel.
 - **FREQUENCY tuning:** It demodulates by using the standard set on the option "Tuning frequency demodulation" (see next).
- 7 Press **HOME**  key to get back to the main screen.

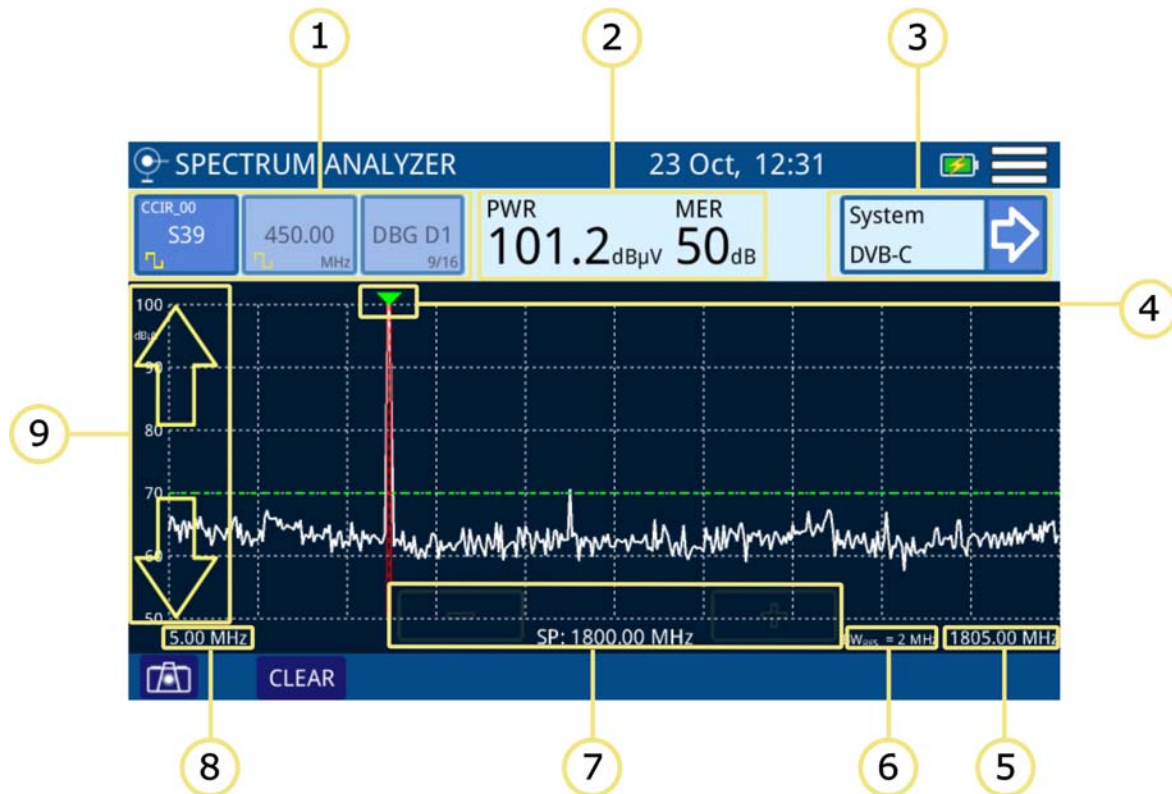
► Screen Description

Figure 8.

- 1** Selection of tune mode: Channel/frequency/DBG. The selected tune mode is highlighted. From left to right are:
 - Channel tuning: It shows the selected channel, channel plan and signal type (digital/analogue). When pressing on it deploys a list of available channels.
 - Frequency tuning: It shows the selected frequency and signal type (digital/analogue). When pressing on it pops up a virtual numeric keypad to edit frequency.
 - Docsis Bonding Group selection (DBG): If the selected channel belongs to a DBG then it appears on this box. When pressing on, it shows a list of DBG available for the current channel plan.
- 2** Measurement of the selected channel: Channel power and MER (for digital channel) / Level (for analogue channel).
- 3** System measurement: It shows the demodulation system for the channel/frequency selected. When pressing on it, it shows the data obtained after signal demodulation for digital channels or additional measurements for analogue signals.
- 4** Marker for selected channel / frequency. Bandwidth of the selected channel is delimited by two continuous and vertical lines.
- 5** Span upper frequency.



- 6 Bandwidth resolution.
- 7 Arrows to increase / decrease span. Current span.
- 8 Span lower frequency.
- 9 Arrows to change reference level.

► **Description of Signal Demodulation Screen**





Figura 9.

- 1 Demodulated Signal.
- 2 Measurement obtained from signal demodulation (for more details refer to ["Demodulator" on page 57](#)).

► **Options Menu**

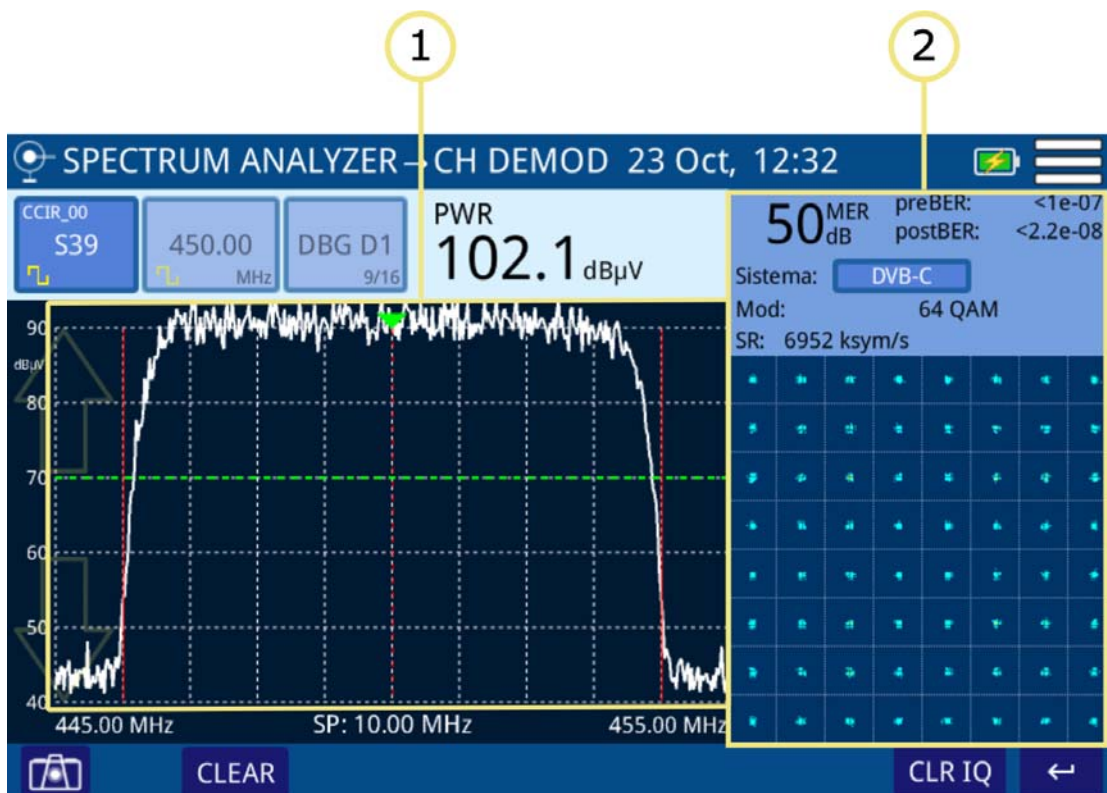
There are some options at the bottom of the screen:

-  : Screenshot.
- **CLEAR**: It clears spectrum trace (this options is available if trace was hold previously).
- **CLR IQ**: It clears the signal constellation.



-  : It comes back to the last screen.

► Settings

Click on the MENU icon  at the upper right corner to access the Settings menu. The **SPECTRUM ANALYZER** function has these options:

- **Edit channel plan:** It allows you to edit a channel plan and DBG (refer to "Edit Channel Plan" chapter).
- **Units:** It allows you to select measurement unit for power (dBuV, dBmV, dBm).
- **Reference line:** It allows you to select the reference line by numbers (-60 dBmV to +70 dBmV). Reference line allows you to define criteria in order to quickly accept or refuse channels levels.
- **Trace:** It allows you to select holding type of trace (maximal, minimum).
- **CTB/CSO:** It allows you to set parameters to measure intermodulation distortion CTB/CSO (Composite Triple Beat / Composite Second Order) that has a big influence on the net quality.
- **Filter:** It allows you to define the frequency filter (230 kHz, 2 MHz or Auto).
- **Frequency tuning:** It allows you to set parameters to demodulate tuned frequency. User must select bandwidth, type of signal (digital, analogue, FM or continuous wave) and other related parameters according to signal.

3.2 Scan (cable & FO)

► Description



The **SCAN** function shows on screen signal level in graphic bar format for each one of the active channels in the selected channel plan.

	SCAN, Datalogger and TILT	S C A N 
---	---	--

► Operation

- 1 Connect signal to the input connector:
 - **Cable:** universal connector for F/F or F/BNC adapter.
 - **Fiber Optics:** SC-APC connector.



- 2 Access home screen by pressing the HOME  key.
- 3 Select **SCAN** function according to input signal (cable or fiber). Press function on the left side of the screen for **FIBER OPTICS** or on the right side for **CABLE**.
- 4 **SCAN** function opens.
- 5 Press **SYSTEM** to demodulate signal and show constellation.
- 6 To quit press **HOME**  key.

► **Screen Description**

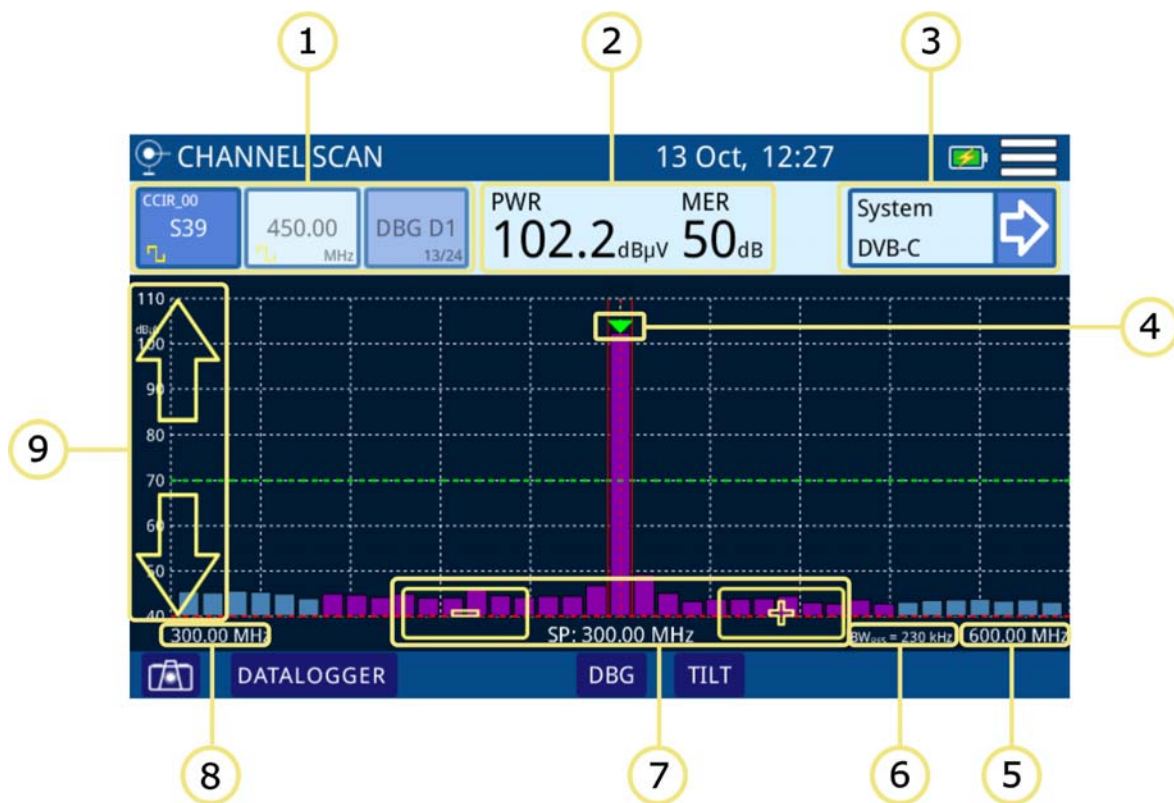

Figure 10.

- 1 Selection of tune mode: Channel/frequency/DBG. The selected tune mode is highlighted. From left to right are:
 - Channel tuning: It shows the selected channel, channel plan and signal type (digital/analogue). When pressing on it deploys a list of available channels.
 - Frequency tuning: It shows the selected frequency and signal type (digital/analogue). When pressing on it pops up a virtual numeric keypad to edit frequency.



- Docsis Bonding Group selection (DBG): If the selected channel belongs to a DBG then it appears on this box. When pressing on it, it shows a list of DBG available for the current channel plan.
- 2 Measurement of the selected channel: Channel power and MER (for digital channel) / Level (for analogue channel).
- 3 System measurement: It shows the demodulation system for the channel/frequency selected. When pressing on it, it shows the data obtained after signal demodulation for digital channels or additional measurements for analogue signals.
- 4 Marker for selected channel / frequency. Bandwidth of the selected channel is delimited by two continuous and vertical lines.
- 5 Span upper frequency.
- 6 Bandwidth resolution.
- 7 Arrows to increase / decrease span. Current span.
- 8 Span lower frequency.
- 9 Arrows to change reference level.

► **Description of DBG SCAN screen**



Figura 11.

- 1 Power for each DBG carrier. The arrow on the bar shows the selected carrier.

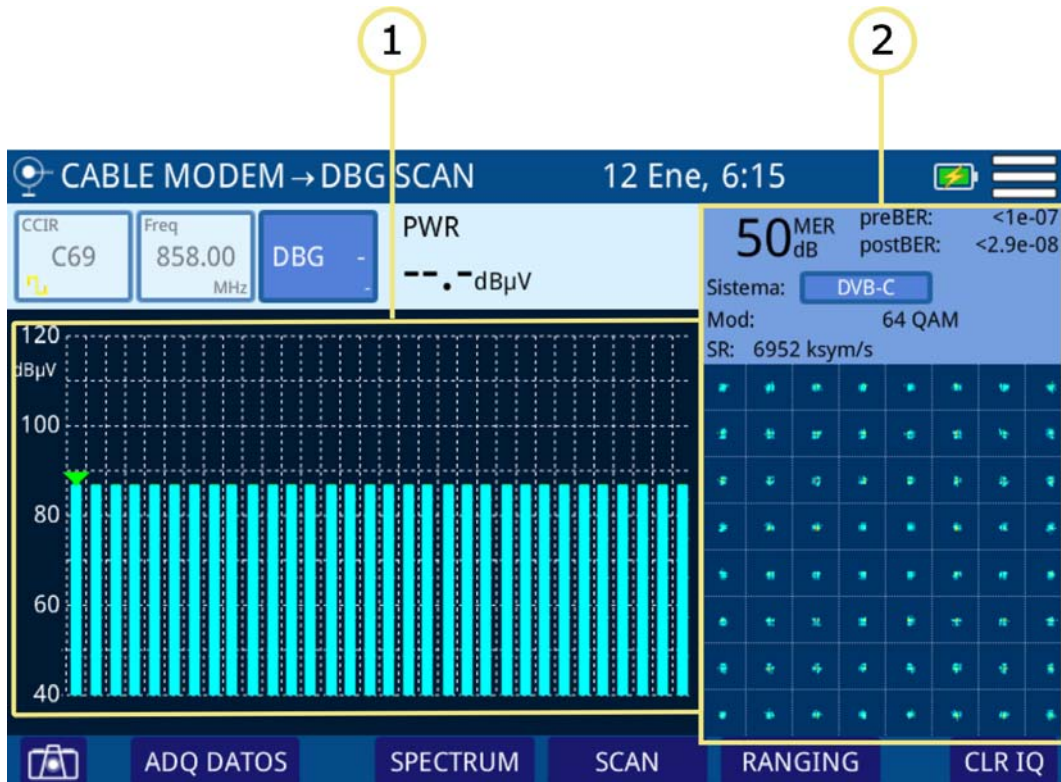

- 2 Graphical representation of the Constellation Diagram and measurement for the channel pointed by the marker.

► Options Menu

There are some options at the bottom of the screen:

-  : Screenshot.
- **DATALOGGER**: It creates a datalogger with measurement data.
- **DBG**: It accesses the DBG function that shows the channels belonging to the Docsis Bonding Group and also demodulates the selected channel.
- **TILT**: It accesses the TILT function (for more details see next).

► Settings Menu

Click on the **MENU**  icon at the upper right corner to access the Settings menu. The **SCAN** function has these options:

- **Edit channel plan**: It allows you to edit a channel plan and DBG (refer to "Edit Channel Plan" chapter).
- **Units**: It allows you to select a measurement unit for power (dBuV, dBmV, dBm).
- **Reference Line**: It allows you to select the reference line by numbers (-60 dBmV to +70 dBmV). Reference line allows you to define criteria in order to quickly accept or refuse channels levels.
- **Threshold**: It allows you to define the power for the signal to appear on screen (-60 dBmV – +70 dBmV). Only channels above this level will show on screen.
- **CTB/CSO**: It allows you to set parameters to measure intermodulation distortion CTB/CSO (Composite Triple Beat / Composite Second Order) that has a big influence on the net quality.

3.3 Tilt (cable & FO)

► Description

The **TILT** function is a test to measure tilt in order to equalize the line. **TILT** is the difference in amplitudes between the minimum and maximum frequency that the system can compensate.



The **TILT** function displays on-screen, graphically and numerically, the difference in level between any four frequencies previously defined as pilots. This function works for upstream and downstream band.



Typically, CATV networks transmit two pilot signals at the beginning and at the end of the band. These two pilots and two more are the ones that can be tuned simultaneously on the screen. By this way you can evaluate the losses slope and therefore readjust equalizers of the amplifiers in order to compensate these losses and ensure a flat response along the band.

	SCAN, Datalogger and TILT	S C A N 
---	---	--

► Operation

- 1 Connect signal to input connector:
 - **Cable:** universal connector for F/F or F/BNC adapter.
 - **Fiber Optics:** SC-APC connector.
- 2 Access home screen by pressing the HOME  key.
- 3 Select the **SCAN** function according to input signal (cable or fiber). Press function on the left side of the screen for **FIBER OPTICS** or on the right side for **CABLE**.
- 4 Then the function **SCAN** appears on screen. Press on TILT at the low right corner to acces the **TILT** function. By default it shows the Downstream channel band.
- 5 Press on the lower right corner to switch between upstream and downstream band.
- 6 Press **HOME**  key to get back to the main screen.



► **Screen Description**

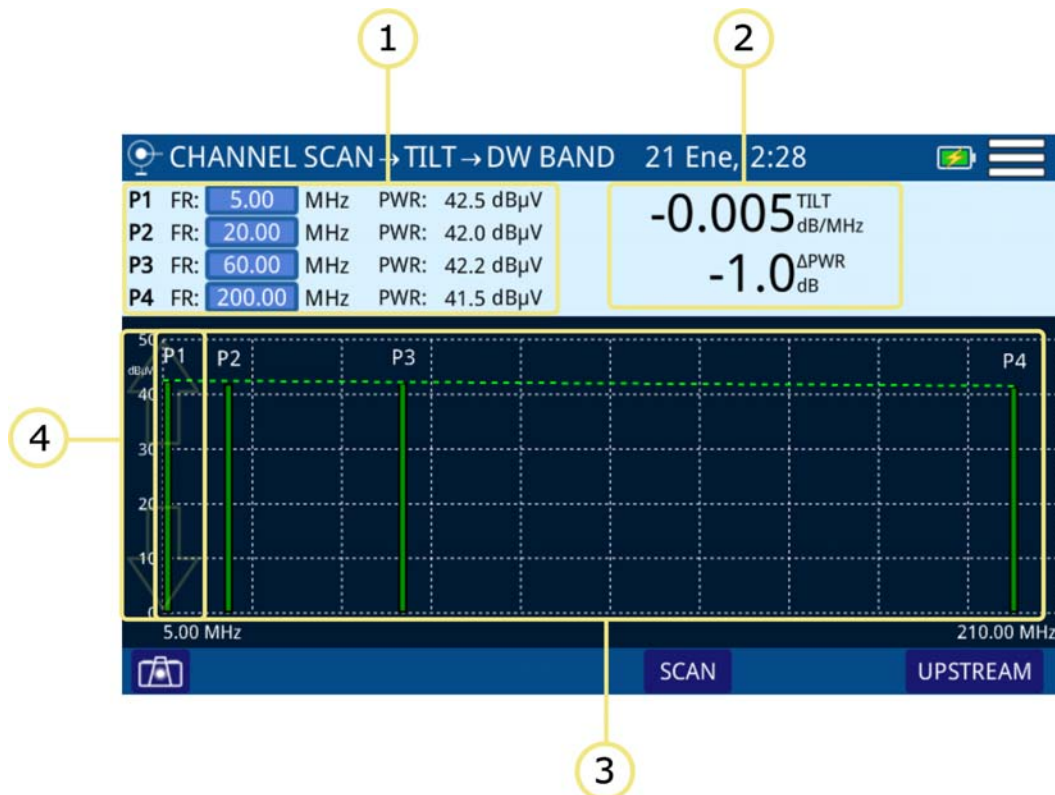



Figure 12.

- 1 P1 - P4: Pilot signals. It shows pilot signal frequency and power. Press on frequency to change its value.
- 2 TILT: Inclination rate in dB per MHz and power difference between P1 and P4.
- 3 Bar graph showing signal level for each pilot signal and TILT.
- 4 Arrows to change reference level.

► **Options Menu**

There are some options at the bottom of the screen:

-  : Screenshot.
- **SCAN**: It accesses the SCAN function (for more details see next).
- **UPSTREAM/DOWNSTREAM**: It allows you to switch between upstream and downstream band. The current band appears on the top of the screen.



► Settings Menu

Click on the  MENU icon at the upper right corner to access the Settings menu. The **TILT** function has these options:

- **Units:** It allows you to select a measurement unit for power (dBuV, dBmV, dBm).

3.4 **SATELLITE (cable & FO)**

► Description

The **SATELLITE** function shows on screen the satellite spectrum signal received through the input connector.

This function shows signals in frequency band so user can detect any problem and also measures level and demodulates signal. También permite alimentar la LNB de la antena de satélite, seleccionando el tipo de voltaje y frecuencia.

User can select span and reference level by selecting a frequency or channel. He also can select detector type (maximum / minimum peak), measurement units and other parameters.

	Satellite Function	S C A N 
---	------------------------------------	---

► Operation

- 1 Connect signal to input connector:
 - **Cable:** universal connector for F/F or F/BNC adapter.
 - **Fiber Optics:** SC-APC connector.
- 1 Access home screen by pressing the HOME  key.
- 2 Select the **SATELLITE** function according to input signal (cable or fiber). Press function on the left side of the screen for **FIBER OPTICS** or on the right side for **CABLE**.
- 3 Then the function **SATELLITE** appears on screen.
- 4 Select channel or frequency.
- 5 To obtain more information about the signal press on **SYSTEM:**
 - **CHANNEL tuning:** By default it demodulates by using the standard which is defined on the channel plan for the selected channel.



- **FREQUENCY tuning:** It demodulates by using the standard set on the option "Frequency tuning" (see next).

6 Press **HOME**  key to get back to the main screen.

► **Screen Description**



Figura 13.

- 1 Selection of tune mode: Channel/frequency. The selected tune mode is highlighted. From left to right are:
 - Channel tuning: It shows the selected channel, channel plan and signal type (digital/analogue). When pressing on it deploys a list of available channels.
 - Frequency tuning: It shows the selected frequency and signal type (digital/analogue). When pressing on it pops up a virtual numeric keypad to edit frequency.
- 2 Measurement of the selected channel: Channel power and MER.
- 3 System measurement: It shows the demodulation system for the channel/frequency selected. When pressing on it, it shows the data obtained after signal demodulation for digital channels or additional measurements for analogue signals.
- 4 Span upper frequency.
- 5 Bandwidth resolution.

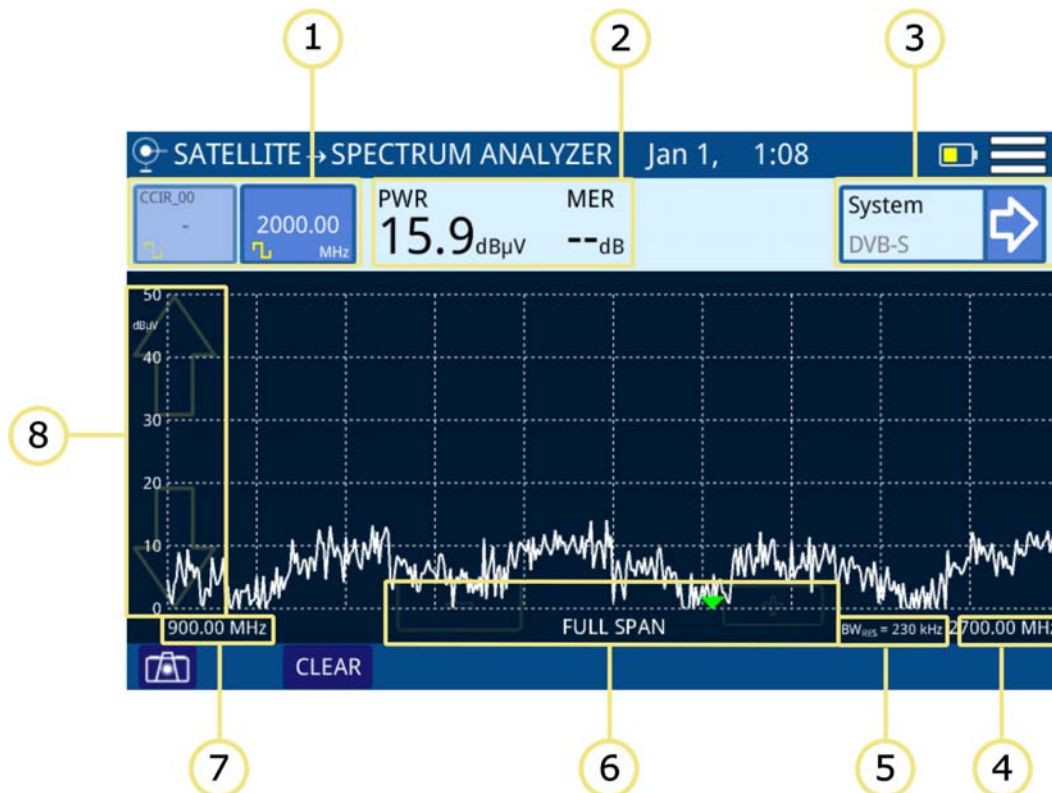

- 6 Arrows to increase / decrease span. Current span.
- 7 Span lower frequency.
- 8 Arrows to change reference level.

► **Description of Signal Demodulation Screen**



Figura 14.

- 1 Demodulated Signal.
- 2 Measurement obtained from signal demodulation (for more details refer to ["Demodulator" on page 57](#)).

► **Options Menu**

There are some options at the bottom of the screen:

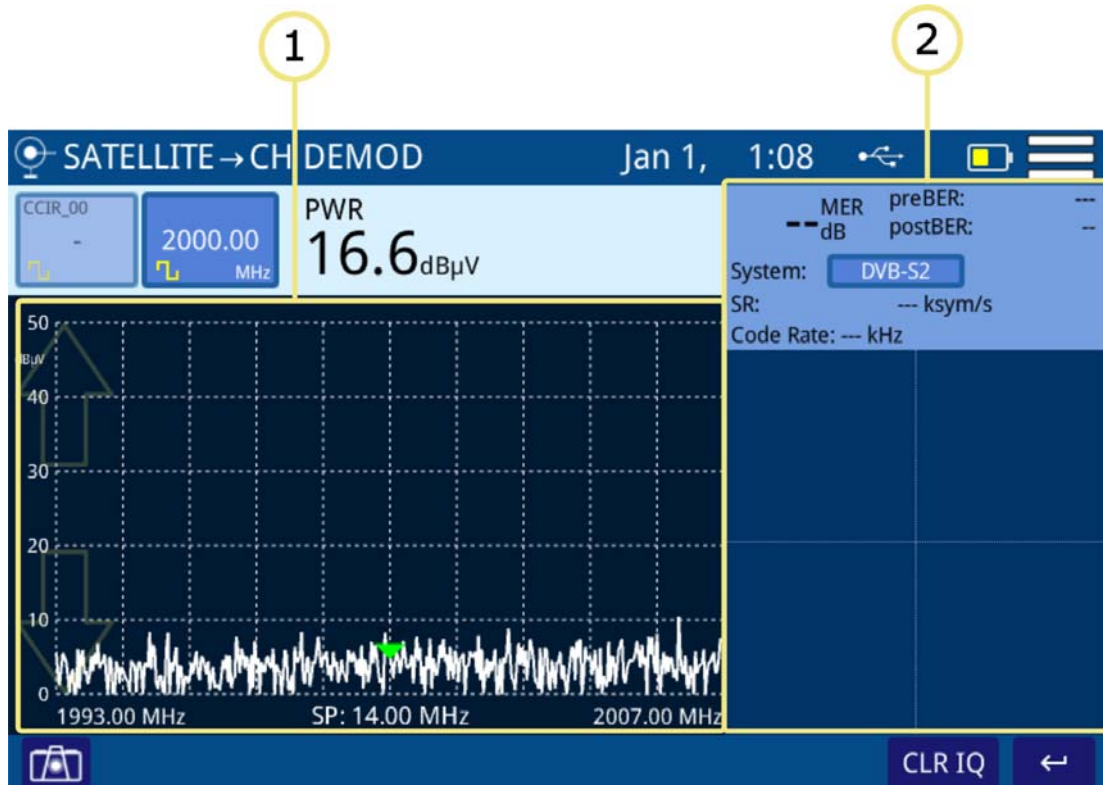
- : Screenshot.
- **CLEAR**: It clears spectrum trace (this options is available if trace was hold previously).
- **CLR IQ**: It clears the signal constellation.
- : It comes back to the main screen.



► **Settings**

Click on the MENU icon  at the upper right corner to access the Settings menu. The **SATELLITE** function has these options:

- **Edit channel plan:** It allows you to edit a channel plan and DBG (refer to "Edit Channel Plan" chapter).
- **Units:** It allows you to select measurement unit for power (dBuV, dBmV, dBm).
- **Reference line:** It allows you to select the reference line by numbers (-60 dBmV to +70 dBmV). Reference line allows you to define criteria in order to quickly accept or refuse channels levels.
- **Trace:** It allows you to select holding type of trace (maximal, minimum).
- **Frequency step:** It allows you to select frequency step (0.25 MHz, 1 MHz, 8 MHz, other value).
- **Frequency tuning:** It allows you to set parameters to demodulate tuned frequency. User must select bandwidth, type of signal (digital, FM or continuous wave). In case of digital, user must select the modulation type (DVB-S/S2) and symbol-rate or check the "Auto" box to detect it automatically.
- **LNB:** It allows the user to enable and select voltage and frequency to feed the LNB. To enable it uncheck the OFF checkbox and select voltage and frequency (13 V, 13 V + 22 KHz, 18 V, 18 V + 22 KHz). Before feeding the LNB it is very important to ensure that no AC/DC voltage is going through input connectors.

3.5 **CABLE MODEM**

► **Introduction**

The Cable Modem includes several functions to know how works a DOCSIS / EURODOCSIS 3.0/3.1* transmission data system. It can emulate a Cable Modem by using its internal Cable Modem.

- Cable Modem functions:
 - DS SPECTRUM:
 - DBG SCAN:
 - SCAN CM:
 - RANGING ->REGISTERING**
 - IPTV
 - VoIP
 - SPEED

*. Demodulation of standard 3.1 (OFDM) only available for **CABLE RANGER 3.1**

** This function is not available for fiber optics



The **DS SPECTRUM** shows spectrum of a signal in the Downstream band.

DBG SCAN function shows power of channels and carrier belonging to DOCSIS BONDING GROUP.

The **SCAN CM** function shows on screen signal level in graphic bar format for each one of the active channels in the cablemodem band.

RANGING (also known as a CABLE MODEM EMULATOR) is a tool to adjust transmission parameters at the CM, such as frequency and power in order to get a stable and aligned communication between CM and CMTS.

REGISTERING allows you to register your equipment in the network. Once registered you can check it with **IPTV**, **VoIP** and **SPEED** tools.

	DOCSIS Measurement and analyzer	S C A N 
---	---	---

► Operation

- 1 Connect signal to the input connector:
 - **Cable:** universal connector for **F/F** or **F/BNC** adapter.
 - **Fiber Optics:** SC-APC connector.
- 2 Access home screen by pressing the HOME  key.
- 3 Select **DOCSIS CABLE MODEM** function according to input signal (cable or fiber). Press function on the left side of the screen for **FIBER OPTICS** or on the right side for **CABLE**.
- 4 The first time the user enters the **DOCSIS CABLE MODEM** function, the CABLE MODEM is initialized. An indicator with the letters **CM** will appear in the upper right corner. This indicator appears with a flashing red dot. After a few seconds, if it is successful, the point will turn to green
- 5 The **DS SPECTRUM** is the first screen. It is a spectrum analyser for downstream docsis.
- 6 To analyze a **DOCSIS BONDING GROUP**, select a **DBG** and then press on **DBG SCAN**.
- 7 To perform a scan of Cable Modem channels, press on **SCAN CM**.
- 8 To perform a **RANGING** (also called **CABLEMODEM Emulation**) from the internal **CABLE MODEM** of the equipment press on **RANGING***. The **RANGING** generates an UPSTREAM signal at the frequency and power required to connect to the CMTS.

*. This function is not available for fiber optics



- 9 Then, to work as CABLEMODEM giving and receiving information, it is necessary to register it on the network. Once registered you will be able to perform the tests of IPTV, VoIP and Speed.
- 10 For more information about **DOCSIS ANALYZER** functions refer to next sections.

3.5.1 DS SPECTRUM (cable & FO)

► **Description**

DS SPECTRUM function shows signal spectrum in the Downstream band.

► **Screen Description**

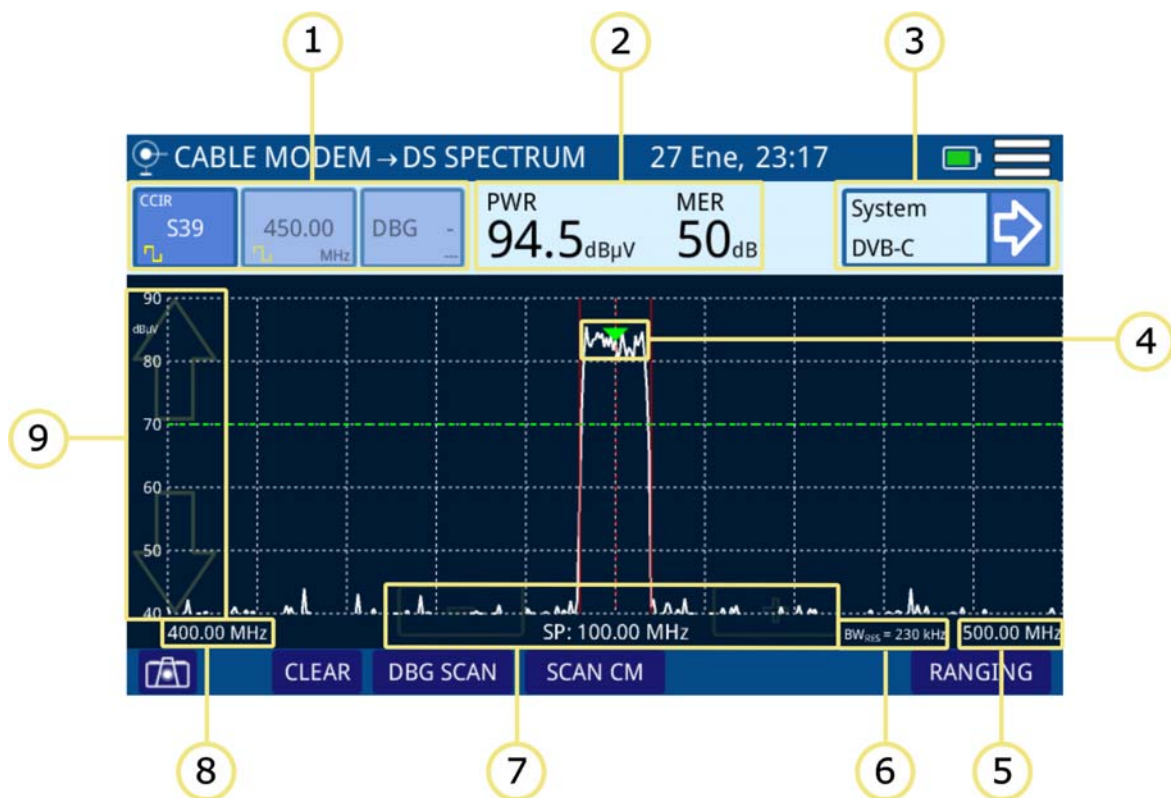

Figure 15.

- 1 Selection of tune mode: Channel/frequency/DBG. The selected tune mode is highlighted. From left to right are:
 - Channel tuning: It shows the selected channel, channel plan and signal type (digital/analogue). When pressing on it deploys a list of available channels.



- Frequency tuning: It shows the selected frequency and signal type (digital/analogue). When pressing on it pops up a virtual numeric keypad to edit frequency.
- Docsis Bonding Group selection (DBG): If the selected channel belongs to a DBG then it appears on this box. When pressing on it, it shows a list of DBG available for the current channel plan.
- 2** Measurement of the selected channel: Channel power and MER (for digital channel) / Level (for analogue channel).
- 3** System measurement: It shows the demodulation system for the channel/frequency selected. When pressing on it, it shows the data obtained after signal demodulation for digital channels or additional measurements for analogue signals.
- 4** Marker for selected channel / frequency. Bandwidth of the selected channel is delimited by two continuous and vertical lines.
- 5** Span upper frequency.
- 6** Bandwidth resolution.
- 7** Arrows to increase / decrease span. Current span.
- 8** Span lower frequency.
- 9** Arrows to change reference level.

► Options Menu

There are some options at the bottom of the screen:

-  : Screenshot.
- **CLEAR**: It clears spectrum trace (this options is available if trace was hold previously).
- **DBG SCAN**: It opens the DBG SCAN function (see next section).
- **SCAN CM**: It opens the CABLE MODEM SCAN function (see next section).
- **RANGING** (only for CABLE): It enables the RANGING function (see next section).

► Settings Menu

Click on the  MENU icon at the upper right corner to access the Settings menu. The **DOCSIS DOWNSTREAM SPECTRUM ANALYZER** function has these options:

- **Edit channel plan**: It allows you to edit a channel plan and DBG (refer to "Edit Channel Plan" chapter).
- **Units**: It allows you to select measurement unit for power (dBuV, dBmV, dBm).



- **Reference Line:** It allows you to select the reference line by numbers (-60 dBmV to +70 dBmv). Reference line allows you to define criteria in order to quickly accept or refuse channels levels.
- **Trace:** It allows you to select holding type of trace (maximal, minimum).
- **CTB/CSO:** It allows you to set parameters to measure intermodulation distortion CTB/CSO (Composite Triple Beat / Composite Second Order) that has a big influence on the net quality.
- **Filter:** It allows you to define the frequency filter (230 kHz, 2 MHz or Auto).
- **Frequency tuning:** It allows you to set parameters to demodulate tuned frequency. User must select bandwidth, type of signal (digital, analogue, FM or continuous wave) and other related parameters according to signal.
- **Att CM:** It enables / disables the CableModem attenuation.
- **CM information:** Information about cable modem software and MAC address.

3.5.2 **DBG SCAN (cable & FO)**

► **Description**

DBG SCAN function shows the signal level in graphic bar format for each one of the active channels in the cablemodem band.



► DBG SCAN Screen Description

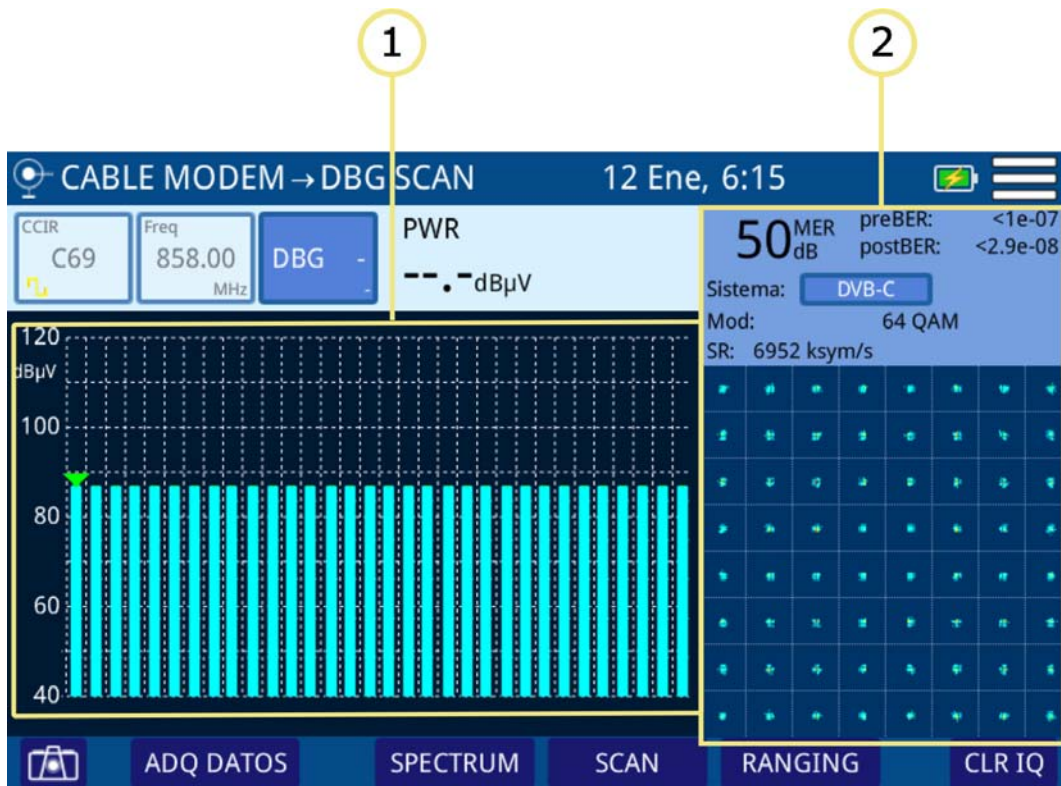

Figure 16.

- 1** Power for each DBG carrier. Arrow on the bar indicates which carrier is selected.
- 2** Constellation Diagram and measurements for the channel pointed by the marker.

► Options Menu

There are some options at the bottom of the screen:

- : Screenshot.
- **DATALOGGER:** It creates a datalogger with measurement data.
- **SPECTRUM:** It returns to the DOCSIS DOWNSTREAM SPECTRUM ANALYZER function (see previous section).
- **SCAN:** It opens the CABLE MODEM SCAN function (see next section).
- **RANGING:** (only for CABLE) It enables the RANGING function (see next section).
- **CLR IQ:** It clears Constellation Diagram.



► **Settings**

Click on the **MENU**  at the upper right corner to access the Settings menu. The **DOCSIS BONDING GROUP** function has these options:

- **Units:** It allows you to select the measurement unit for power (dBuV, dBmV, dBm).
- **Att CM:** It enables / disables Cable Modem attenuation..

3.5.3 CABLE MODEM SCAN (cable & FO)

► **Description**

The **SCAN CM** function shows on screen the signal level in graphic bar format for each one of the active channels for the cablemodem band.

► **Screen Description**

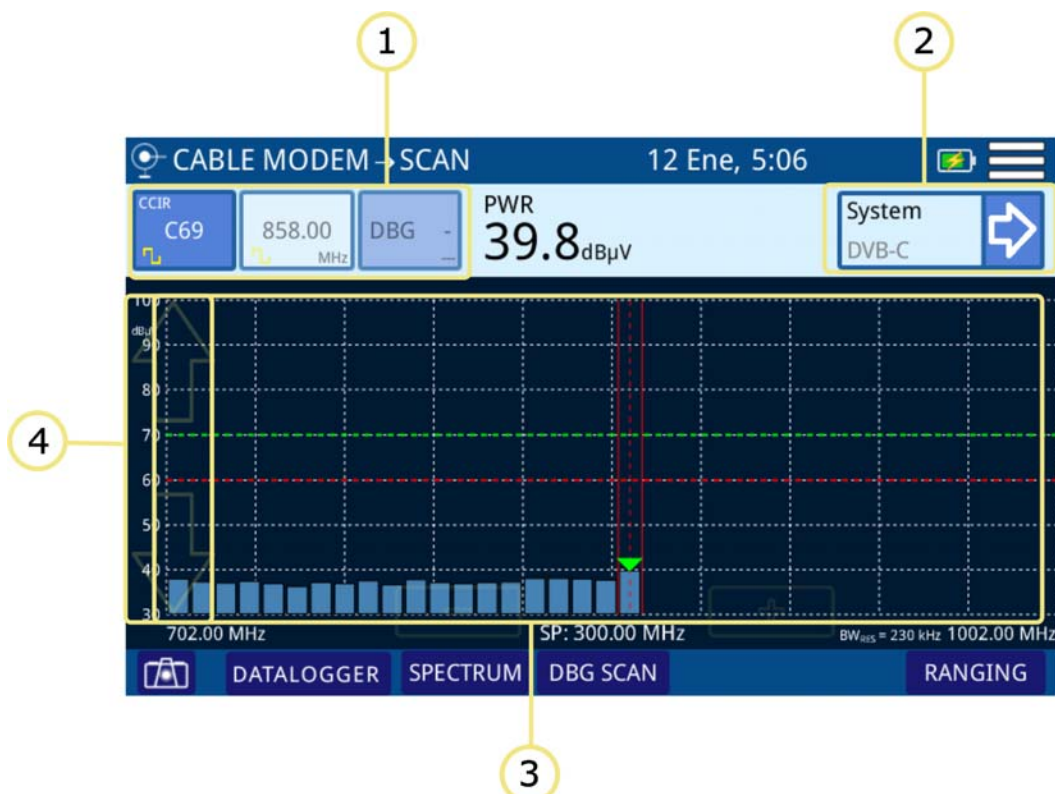

Figure 17.

- 1** Selection of tune mode: Channel/frequency/DBG. The selected tune mode is highlighted. From left to right are:



- Channel tuning: It shows the selected channel, channel plan and signal type (digital/analogue). When pressing on it deploys a list of available channels.
 - Frequency tuning: It shows the selected frequency and signal type (digital/analogue). When pressing on it pops up a virtual numeric keypad to edit frequency.
 - Docsis Bonding Group selection (DBG): If the selected channel belongs to a DBG then it appears on this box. When pressing on it, it shows a list of DBG available for the current channel plan.
- 2 Measurement of the selected channel: Channel power and MER (for digital channel) / Level (for analogue channel).
 - 3 System measurement: It shows the demodulation system for the channel/frequency selected. When pressing on it, it shows the data obtained after signal demodulation for digital channels or additional measurements for analogue signals.
 - 4 Marker for selected channel / frequency. Bandwidth of the selected channel is delimited by two continuous and vertical lines.
 - 5 Span upper frequency.
 - 6 Bandwidth resolution.
 - 7 Arrows to increase / decrease span. Current span.
 - 8 Span lower frequency.
 - 9 Arrows to change reference level.

3.5.4 **RANGING (cable)**

► Description

The RANGING function (also called CABLEMODEM emulation) connects internal **CABLEMODEM** of the equipment to CMTS and generates an UPSTREAM signal. Tune a carrier from SPECTRUM or DBG then press RANGING to connect to CMTS. Equipment shows frequency and power required to connect to the CMTS.



► **Screen Description**

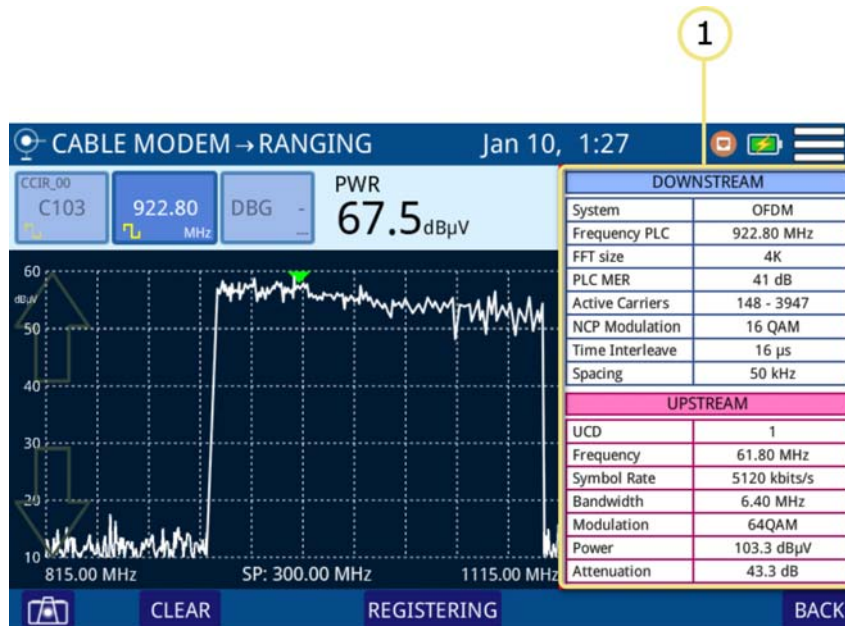

Figure 18.

1 Data for Downstream channel and Upstream ranging.

► **Downstream**

- System: Transmission standard.
- SR: Symbol Rate.
- MOD: Modulation.
- MER: Modulation Error Ratio.
- PreBER: Error ratio before correction.
- PostBER: Error ratio after correction.
- Interleaver: Improvement of error correction performance.
- Offset: Offset for tuning frequency.

► **Downstream (OFDM modulation)**

- System: Transmission standard.
- Frequency PLC: PLC channel frequency.
- FFT Size: Amount of subcarriers.
- PLC MER: MER of PLC channel.
- Active Carriers: Active carriers.



- NCP Modulation: Codeword NCP modulation.
- Time Interleave: Improvement of error correction performance.
- Spacing: Spacing between subcarriers.

► Upstream

- UCD: Upstream Channel Descriptor.
- Frequency: Channel frequency.
- Symbol Rate.
- Bandwidth: Channel bandwidth.
- Modulation.
- Power: Channel power to CMTS.
- Attenuation: Channel attenuation to CMTS.

► Options Menu

There are some options at the bottom of the screen:

-  : Screenshot.
- **CLEAR**: It clears spectrum trace (this options is available if trace was hold previously).
- **REGISTERING**: It accesses the screen to register in the CMTS (see next section).
- **BACK**: It comes back to the DS SPECTRUM.

► Settings

Click on the **MENU**  at the upper right corner to access the Settings menu. The **RANGING** function has these options:

- **Units**: It allows you to select the measurement unit for power (dBuV, dBmV, dBm).
- **Att CM**: It enables / disables Cable Modem attenuation.
- **OFDM DS**: It allows you to select between 1 DS or 2 DS.



3.5.5 REGISTERING (cable)

► Description

It is necessary to register your equipment in the CMTS network to access functions to check VoIP, IPTV and Speed. When registering, Bonding Downstream, OFDM* Downstream and Upstream features are shown on screen and also some info about the network.

► Screen Description

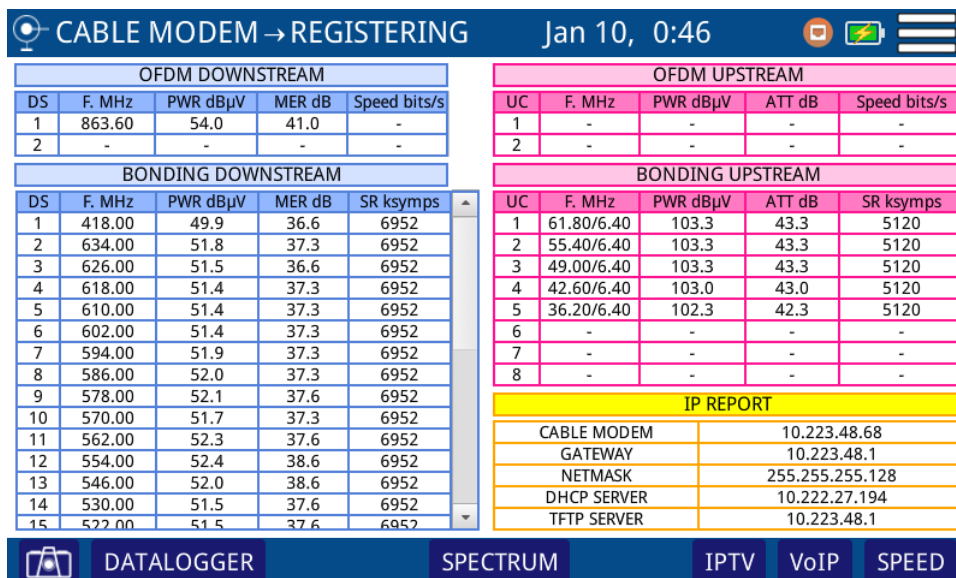

Figure 19.

Downstream

- DS: Downstream channel.
- F: Frequency (MHz).
- PWR: Power (dBmV).
- MER: Modulation Error Ratio (dB).
- SR: Symbol Rate (ksymps).
- Profiles**.

*. Demodulation for OFDM standard only available for **CABLE RANGER 3.1**

** Only available for **CABLE RANGER 3.1**



Upstream

- UC: Upstream Channel.
- F: Frequency (MHz).
- PWR: Power (dBmV).
- ATT: Channel attenuation (dB).
- SR: Symbol Rate (ksyms).
- Speed (bits/s).

IP Report

- Cable Modem: IP for cable modem.
- Gateway: Gateway IP.
- Netmask.
- DHCP Server: IP for DHCP server.
- TFTP Server: IP for file transfer server.

► Options Menu

There are some options at the bottom of the screen:

-  : Screenshot.
- **DATALOGGER**: It creates a datalogger with measurement data.
- **BACK**: It comes back to DS SPECTRUM screen.
- **IPTV**: It opens TEST IPTV function (see next section).
- **VoIP**: It opens TEST VoIP function (see next section).
- **SPEED**: It opens TEST SPEED function (see next section).

► Setting Menu

Click on the **MENU**  icon at the upper right corner to access the Settings menu. The REGISTERING function has these options:

- **Units**: It allows you to select the measurement unit for power (dBuV, dBmV, dBm).
- **Att CM**: It enables / disables Cable Modem attenuation.



3.5.6 IPTV (cable)

► Description

The IPTV test function performs an analysis of quality parameters for this type of service. The optimization of these parameters guarantees the best quality of service. In addition, knowledge of network conditions is important to install and fix other problems.

► Screen Description

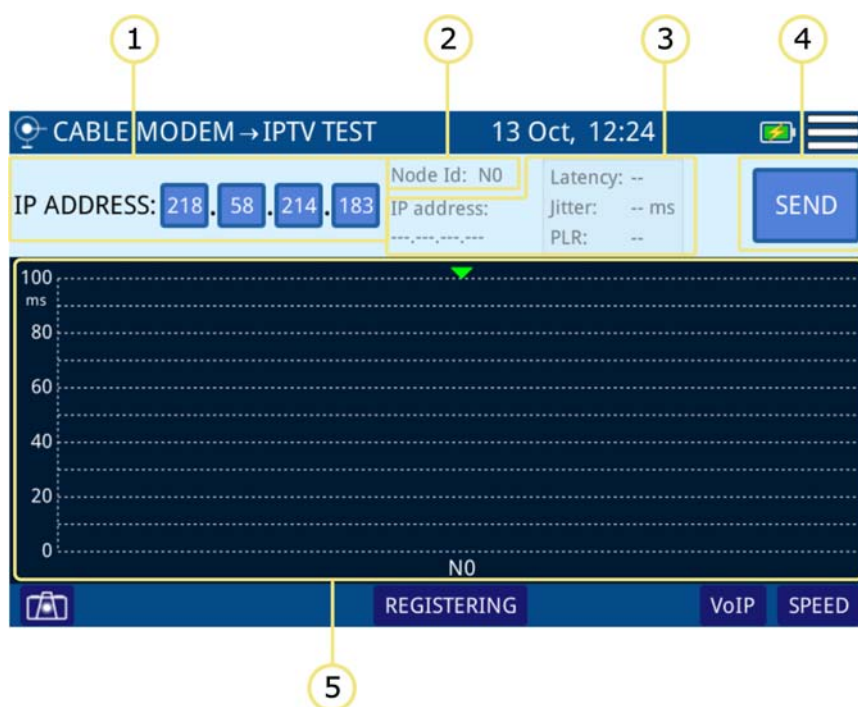



Figure 20.

- 1** It allows you to enter the IP address where sending the test signal.
- 2** Node id: It shows the selected node.
- 3** It shows some parameters obtained from test:
 - IP address: IP address to test.
 - Latency: Delay due to transport or processing.
 - Jitter: Variation of latency over time.
 - PLR (Packet Loss Rate): Percentage of lost packets over total sent packets.
- 4** Send / Stop: It starts / stop the IPTV test.
- 5** Graph with intermediate nodes and time (ms) for the test signal.



► Options Menu

There are some options at the bottom of the screen:

-  : Screenshot.
- **REGISTERING**: It returns to the REGISTERING function (see previous section).
- **VoIP**: It opens TEST VoIP function (see next section).
- **SPEED**: It opens TEST SPEED function (see next section).

► Settings Menu

Click on the MENU  icon at the upper right corner to access the Settings menu. The IPTV function has these options:

- **Enable RTPS (Real Time Polling Service)**: It enables / disables RTPS service.
- **Nominal Polling Interval**: Time interval (ms) between successive requests.

3.5.7 VoIP (cable)

► Description

The **VoIP** function performs a comprehensive analysis of the network based on parameters defined by UGS, which guarantees the best quality of service. It analyzes several parameters that can affect quality of communication such as latency, jitter, lost packets, MOS and R value.



► **Screen Description**

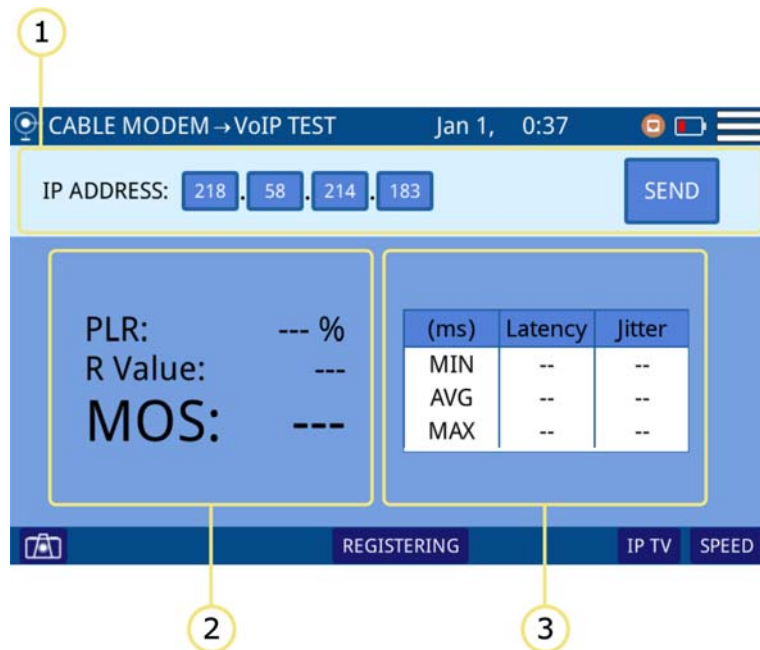



Figure 21.

- 1** Enter the IP address to test and press SEND. Press STOP to stop the test.
- 2** It shows values obtained during test.
 - **PLR (Packet Loss Rate):** Percentage of lost packets over total sent packets.
 - **R VALUE:** It shows a number or score, that is used to quantitatively express the subjective quality of speech in communications systems. Can range from 1 (worst) to 100 (best).
 - **MOS (Mean Opinion Score):** It is a numerical indication of the perceived quality of received media after compression and/or transmission. The MOS is expressed as a single number in the range 1 (lowest quality) to 5 (highest quality).
- 3** It shows minimum, average and maximum measurements for parameters:
 - **Latency:** It is the time delay due to transport or processing.
 - **Jitter:** It is time variation of latency inside the network.

► **Options Menu**

There are some options at the bottom of the screen:

-  : Screenshot.
- **REGISTERING:** It returns to the REGISTERING function (see previous section).



- **IPTV:** It opens IPTV function (see next section).
- **SPEED:** It opens TEST SPEED function (see next section).

► Settings Menu

Click on the **MENU** icon at the upper right corner to access the Settings menu. The **VoIP** function has these options:

- PING Settings:
 - PING data length.
 - PINGs number.
- Quality of Service (UGS) settings:
 - Unsolicited Grant Size.
 - Grants per interval.
 - Nominal Grant Interval.
 - Tolerated Grant Jitter.
 - Codec.

3.5.8 SPEED TEST (cable)

► Description

The SPEED TEST function allows you to check speed on your internet connection for both upload and download channels.

► Screen Description

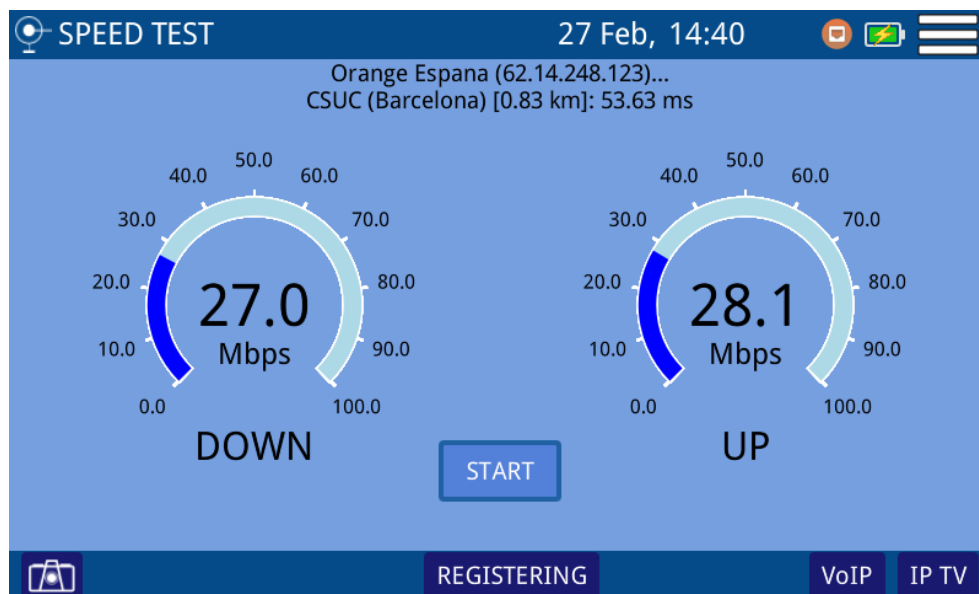



Figure 22.



- Press **START** to start the speed test. It measures download and upload channel speed. It also gets some data from the service provider.

► Options Menu

There are some options at the bottom of the screen:



-  : Screenshot.
- **REGISTERING**: It returns to the REGISTERING function (see previous section).
- **VoIP**: It opens TEST VoIP function (see next section).
- **IPTV**: It opens IPTV function (see next section).

3.6 External CM / Upstream Spectrum (cable)

► Description

The External CM / Upstream Spectrum function extracts a sample of the upstream signal and displays its spectrum on the screen. Connect the CABLEMODEM to the "EXT CM" input and the cable from the CMTS to the "RF" input. The equipment works as a bypass and the display shows the transmission signal (bursts) from the CABLEMODEM to the CMTS. It is recommended to enable the peak detector to view bursts better.

► Operation

- 1 Connect signal to input connector:
 - **Cable**: universal connector for F/F or F/BNC adapter.
 - **External CableModem**: universal connector for F/F or F/BNC adapter (EXT CM).
 - **External CableModem**: Ethernet (ETH) connector.
- 2 Access home screen by pressing the HOME key .
- 3 Select **EXT. CM / UPSTREAM** function.
- 4 Then on screen appears the EXTERNAL CM / UPSTREAM SPECTRUM function.
- 5 Press HOME  to get back to the main screen.



► Screen Description

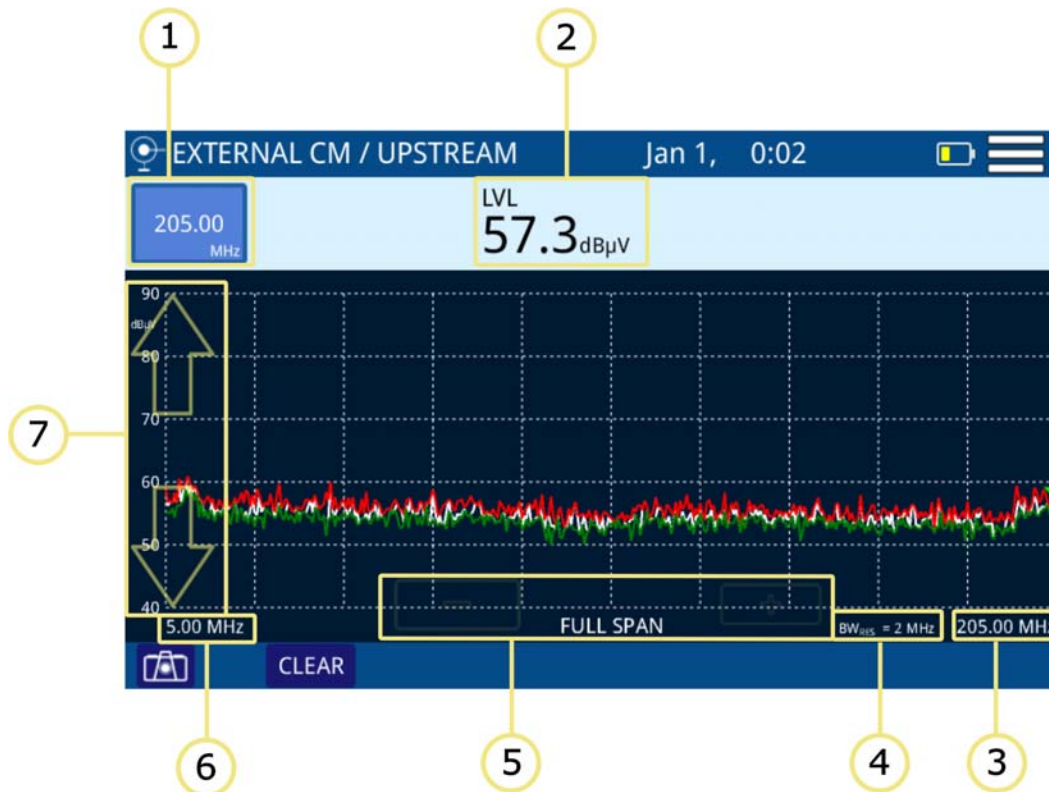

Figure 23.

- 1 Frequency selected. When pressing on it pops up a virtual numeric keypad to edit frequency.
- 2 Power level at selected frequency.
- 3 Span upper frequency.
- 4 Bandwidth resolution.
- 5 Arrows to increase / decrease span. Current span.
- 6 Span lower frequency.
- 7 Arrows to change reference level.

► Options Menu

There are some options at the bottom of the screen:

- : Screenshot.
- **CLEAR**: It clears spectrum trace (this options is available if trace was hold previously).
- **SPEED**: It opens TEST SPEED function (for more details refer to XXX).



► **Settings Menu**

Click on the **MENU**  icon at the upper right corner to access the Settings menu. The **EXT. CM / UPSTREAM** function has these options:.

- **Units:** It allows you to select measurement unit for power (dBuV, dBmV, dBm).
- **Reference line:** It allows you to select the reference line by numbers (-60 dBmV to +70 dBmv). Reference line allows you to define criteria in order to quickly accept or refuse channels levels.
- **Frequency step:** It allows you to select frequency step (0.25 MHz, 1 MHz, 8 MHz, other value).
- **Trace:** It allows you to select holding type of trace (maximal, minimum).
- **Filter:** It allows you to define the frequency filter (230 kHz, 2 MHz or Auto).



3.7 Upstream Test (cable)

► **Description**

The TEST UPSTREAM GENERATOR function, generates a test signal to check Upstream traffic. The device retrieves the signal configuration from the last working session and displays it on the screen.

	<u>Upstream Test and Input Voltage</u>	 S C A N
---	--	---

► **Operation**

- 1 Connect signal to input connector:
 - **Cable:** universal connector for F/F or F/BNC adapter.
- 2 Access home screen by pressing the **HOME** key .
- 3 Select **UPSTREAM TEST** function.
- 4 **TEST UPSTREAM GENERATOR** function opens.
- 5 Press **HOME**  key to get back to the main screen.



► Screen Description

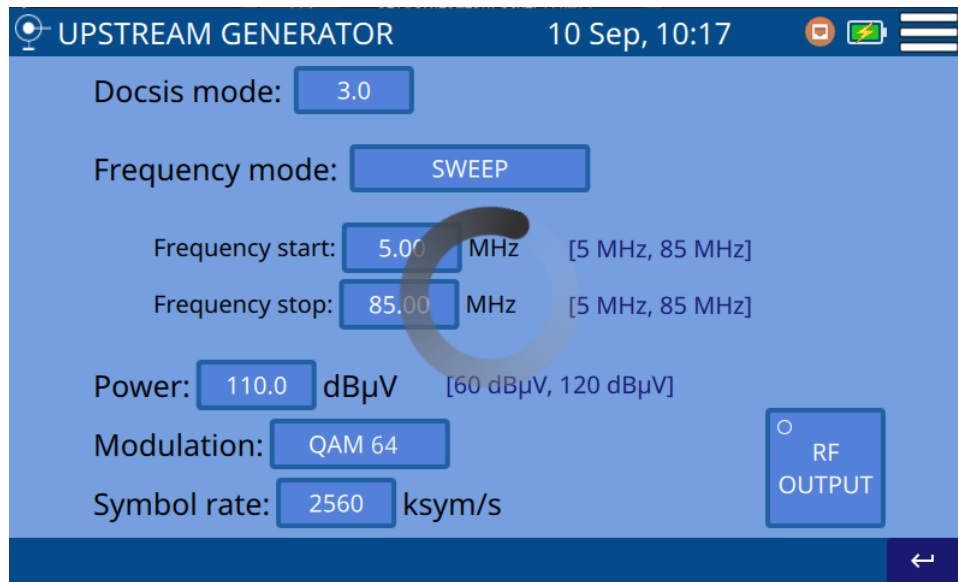

Figure 24.

Parameters to set UPSTREAM signal:

- Docsis mode: To select Docsis* mode.
- Frequency mode: Select between Sweep or Fix.
- Frequency start: Select start frequency (only for Sweep mode).
- Frequency stop: Select stop frequency (only for Sweep mode).
- Frequency: Select frequency (only for Fix mode)
- Power: Select power level for signal.
- Modulation: Select modulation type for signal (QAM 8, 16, 32 UP, 64).
- Symbol Rate: Select symbol rate for test signal (640, 1280, 2560, 5120).
- RF OUTPUT: It enables (green indicator) or disables (off indicator) the test signal. Before starting user must to initialize the Cable Modem (CM indicator at the upper right corner must be in green).

► Settings Menu

Click on the **MENU**  icon at the upper right corner to access the Settings menu. The UPSTREAM TEST GENERATOR function has these options:

*. Mode Docsis 3.1 only available for **CABLE RANGER 3.1**



- **Units:** It allows you to select measurement unit for power (dBuV, dBmV, dBm).



3.8 **Input Voltage (cable)**

► **Description**

The INPUT VOLTAGE function automatically identifies the voltage type (DC or AC) at the input, voltage and frequency in case of alternating current.

	<u>Upstream Test and Input Voltage</u>	
---	--	---

► **Operation**

- 1 Connect signal to the input connector:
 - **Cable:** universal connector for F/F or F/BNC adapter.
- 2 Access home screen by pressing the **HOME** key .
- 3 Select **INPUT VOLTAGE** function.
- 4 **INPUT VOLTAGE** function opens.
- 5 Press **HOME**  key to get back to the main screen.



► **Screen Description**

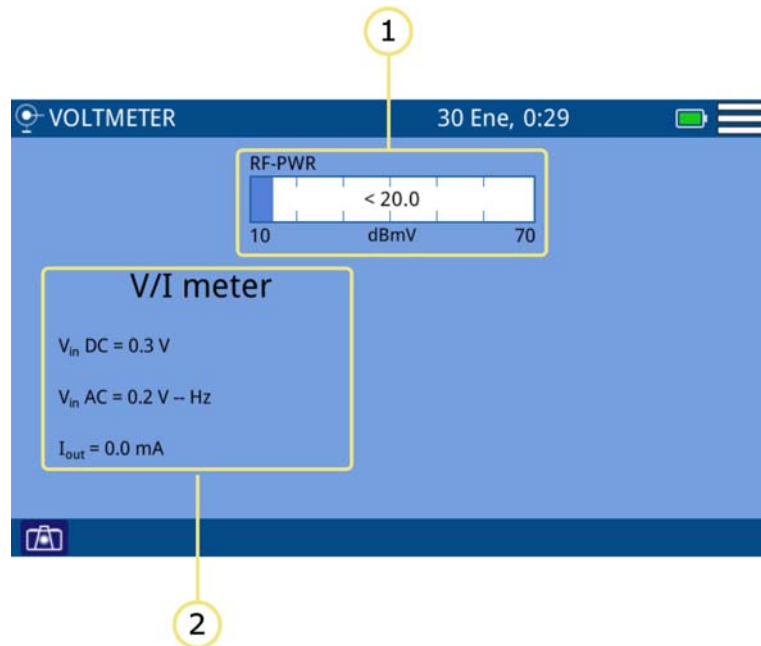

Figure 25.

- 1** RF-PWR: Full bandwidth power.
- 2** V/I meter: Voltage measurement at the input (AC/DC) and output current.

► **Settings Menu**

Click on the **MENU** icon at the upper right corner to access the Settings menu. The **INPUT VOLTAGE** function has these options:

- **Units:** It allows you to select measurement unit for power (dBuV, dBmV, dBm).

3.9 Optical Power Meter (FO)



► **Description**

The OPTICAL POWER METER function measures power for each wavelength by means of a meter calibrated to four wavelengths.

	Optical Power Meter	SCAN
--	-------------------------------------	----------



► **Operation**

- 1 Connect signal to the input connector:
 - **Cable:** universal connector for F/F or F/BNC adapter.
 - **Fiber Optics:** SC-APC connector.
- 2 Access home screen by pressing the HOME key .
- 3 Select **OPTICAL POWER METER** function.
- 4 **OPTICAL POWER METER** function opens.
- 5 Press **HOME**  key to get back to the main screen.

► **Screen Description**

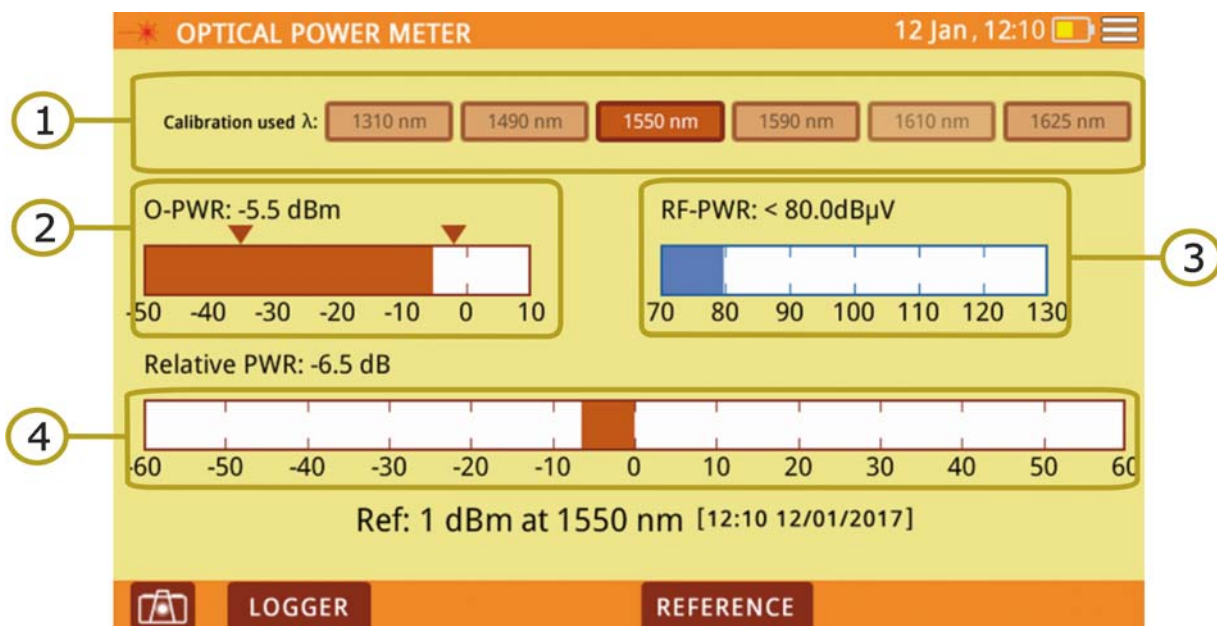



Figure 26.

- 1 Calibration used: Select wavelength for power measurement.
- 2 O-PWER: Graphical bar and value of optical power with high and low threshold. Threshold values can be selected on settings menu.
- 3 RF-PWR: Graphical bar and value of RF power.
- 4 Relative Power: Graphical bar and value of power signal loses. It is equal to:
Relative Power = Reference value - Attenuation.

► **Options Menu**

There are some options at the bottom of the screen:



-  : Screenshot.
- **DATALOGGER**: It creates a datalogger with measurement data.
- **REFERENCE**: It allows you to save current power value as reference value.

► Settings Menu

Click on the **MENÚ**  icon at the right corner to access the Settings menu. The **OPTICAL POWER METER** function has these options:

- **Set optical thresholds**: It allows you to define, select and save sets of threshold values (up to 8 sets). The selected set is shown at the lower screen next to the reference.



4 TOOLS

4.1 Edit Channel Plan

► Description

Channel plan editor allows to edit and create channel plans, and also to edit DBG (Docsis Bonding Group) channels.

► Operation

Channel plan editor is available for **SPECTRUM ANALYZER**, **SCAN/TILT**, **SATELLITE** and **CABLE MODEM**.

- 1 Select channel plan on main screen.
- 2 Access menu by pressing on .
- 3 Press on "Edit Channel Plan" option.
- 4 Wait until the edit channel plan screen opens.
- 5 Press on any parameter / value to edit. To scroll down use the scrolling bar on the right side. Channel selected is in blue background color.
- 6 Press on a parameter to edit. If the parameter is a number, it shows up a virtual keyboard to edit that value. If the parameter value is a text, you should press several times on it to switch among different options.
- 7 Once edited, press on Return key and it appears a window with options: "Save" (it saves changes and exits), "Don't save" (it does not save changes and exits), "Cancel" (it does not saves changes and does not exit).

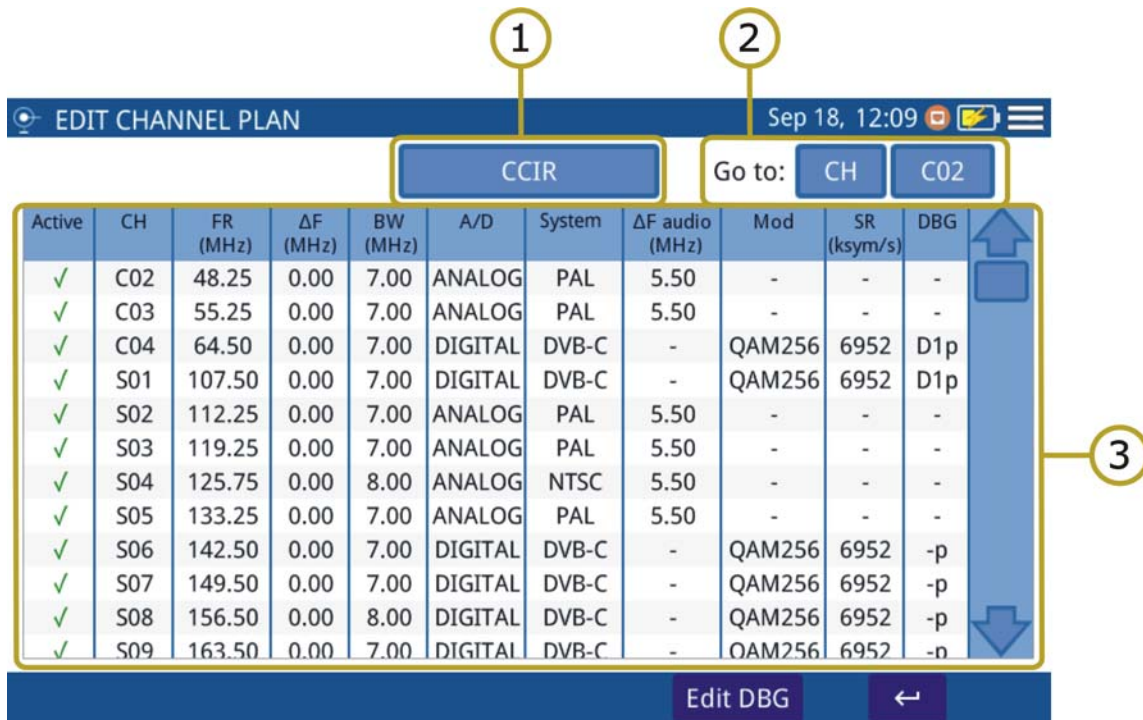
► Screen Description

Figure 27.

- 1** Channel plan selected. Press on this box to select another channel plan.
- 2** Go to: Press on this box to switch between CH (channel) and FR (frequency) and to select a channel or frequency.
- 3** Channel table.

Parameters on channel table are:

- Active: It shows if channel is enabled or disabled.
- CH: Channel.
- FR (MHz): Channel frequency (MHz).
- ΔF (MHz): Offset of tuned frequency for channel (MHz).
- BW (MHz): Bandwidth of channel.
- A/D: It indicates if channel is analogue (A) or digital (D).
- System: It indicates transmission standard (DVB-T/T2, ISDB-T, ITU J83-T, PAL/BG, D3.0, D2.0, E-D2.0, E-D3.0, DVB-C, /C2).
- ΔF Audio (MHz): Offset of tuned frequency for audio (MHz).
- DBG: It shows primary carrier for DBG.



► Options Menu

There are some options at the bottom of the screen:

- **EDIT DBG**: Opens the DBG editor screen (see next section).
- : Back to main screen.

► Settings Menu

Click on the MENU  icon at the upper right corner to access the Settings menu. The EDIT CHANNEL PLAN function has these options:

- **Add new channel**: It adds a new channel for a channel plan (for standard channel plans it is not allowed).
- **Remove channel**: It removes selected channel.
- **New channel plan**: It creates a new channel plan. There are three options (see next section):
 - Clone a channel plan.
 - Automatically create a channel plan by measuring the network.
 - Create a new channel plan.
- **Remove channel plan**: It removes current channel plan.
- **Import standard plan**: It allows you to add standard channel plans that are available in the equipment memory. These channel plans are from several countries where they are often used.

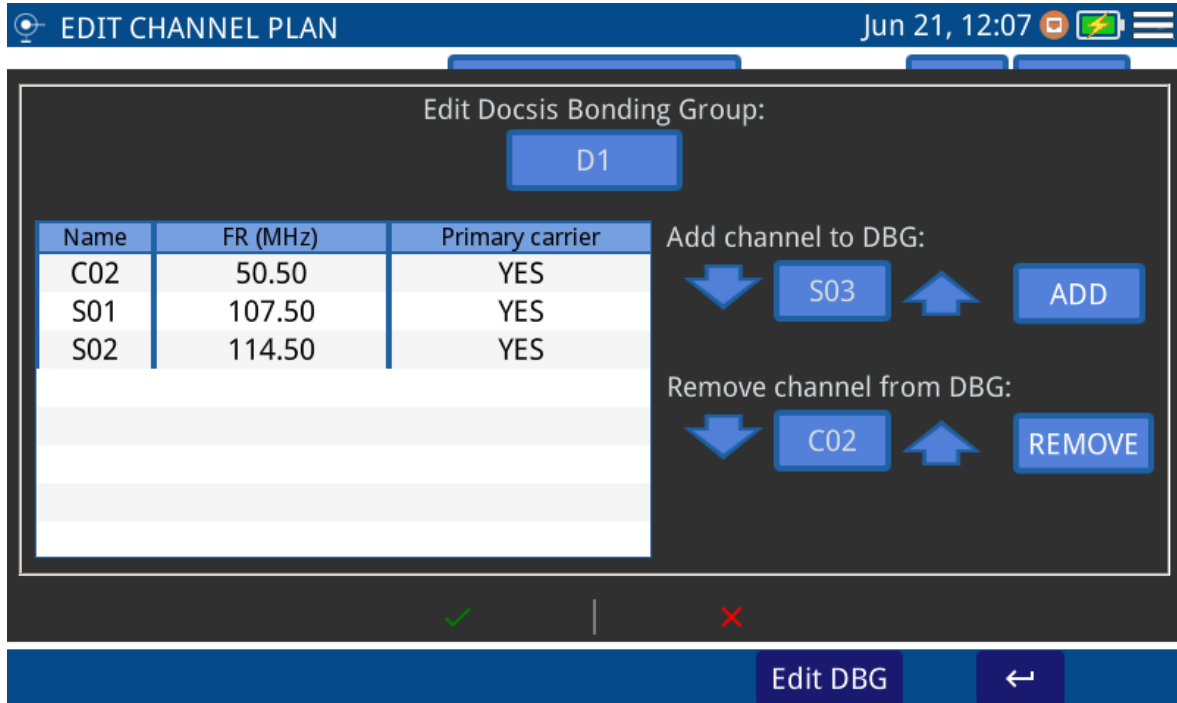
► EDIT DOCSIS BONDING GROUP Screen Description

Figure 28.

- Edit Docsis Bonding Group: Press on the box to select DBG to edit.
- Add channel: Press on arrows or on the box to select one channel and then press on ADD to add to DBG.
- Remove channel: Press on arrows or on the box to select one channel and then press on REMOVE to remove from DBG.
- Primary Carrier: Press on Primary Carrier column to define if that channel is a primary carrier or not.



► **Clone a Channel Plan**

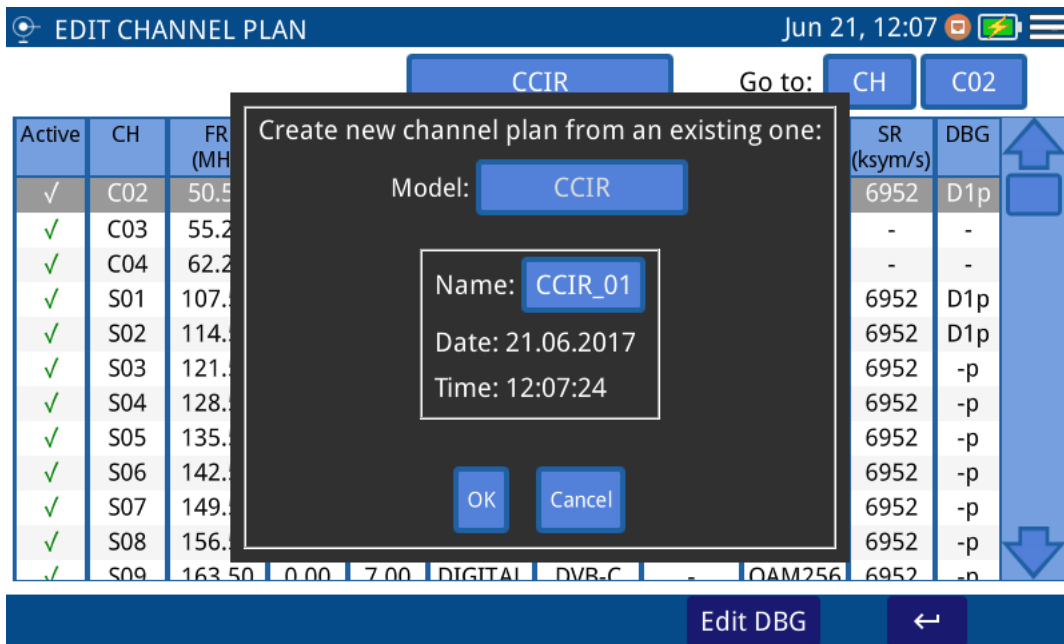

Figure 29.

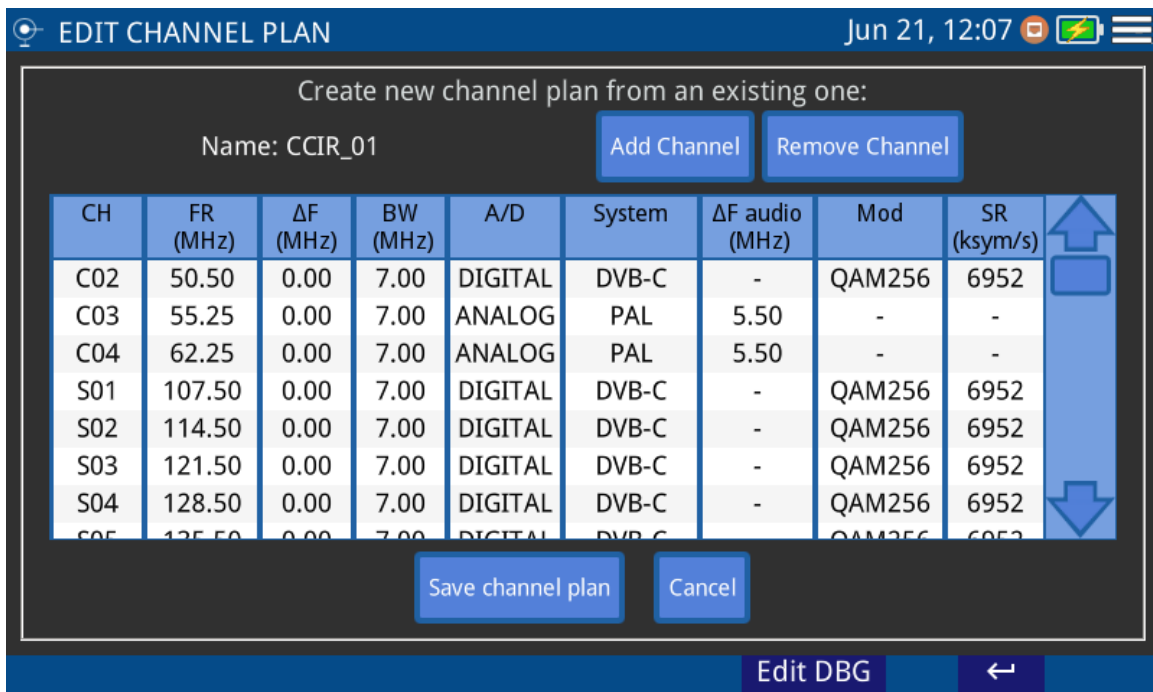

Figure 30.

- 1** Press on box "Model" to select a channel plan as a model to create a new one.
- 2** Press on box "Name" to give a name to the new channel plan.



- 3 Press "OK" to create a new channel plan or "Cancel" to exit.
- 4 At the next screen, press on "Add Channel", "Remove Channel" to edit channel plan. When finish, press on "Save channel plan" to save changes or "Cancel" to exit without saving.

► **Automatically create a channel plan by measuring the network**

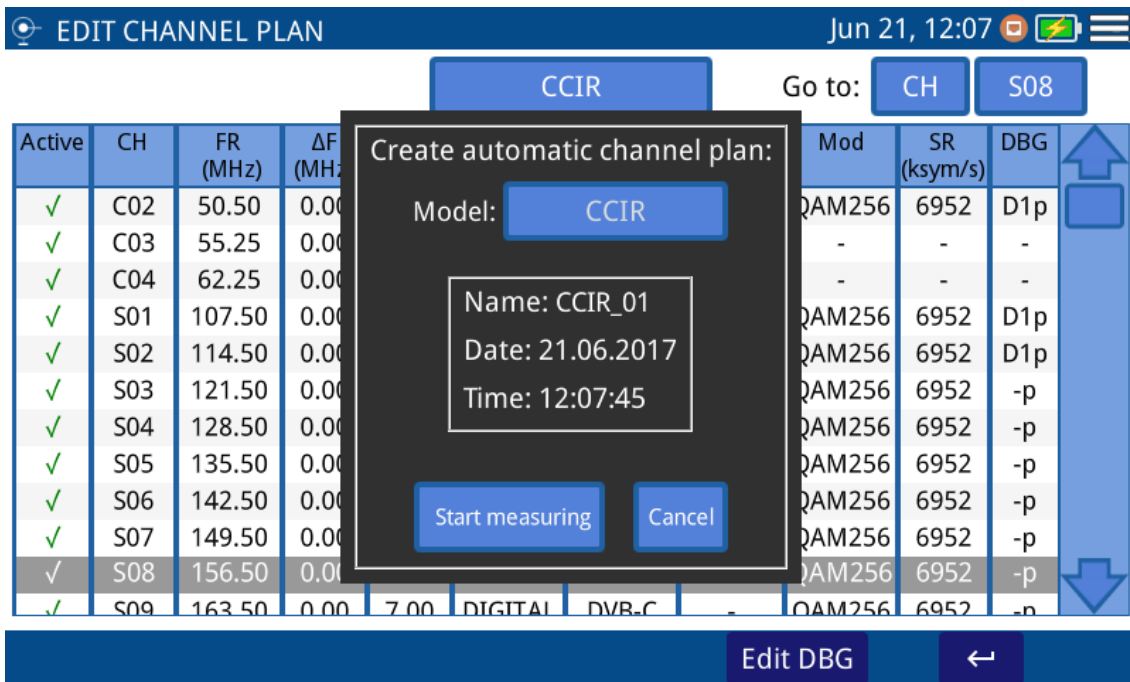

Figure 31.

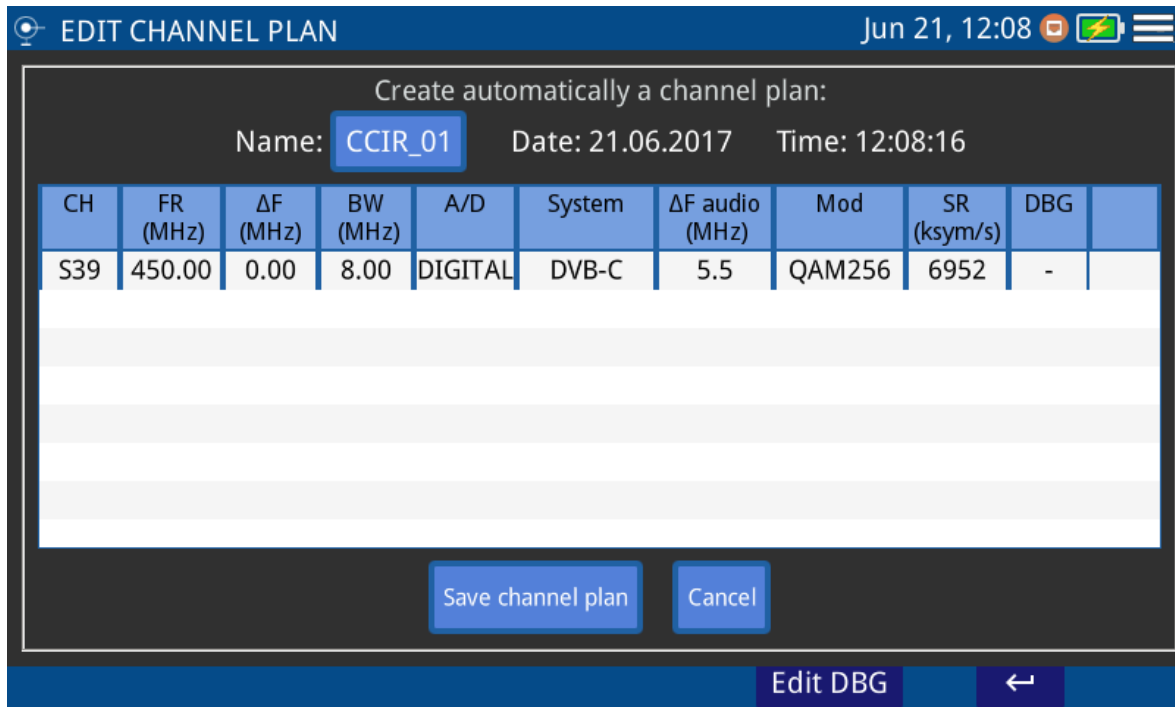

Figure 32.

- 1** Connect to the network.
- 2** Press on box "Model" to select a channel plan as a model to create a new one.
- 3** Select the minimum threshold power for channels and standard (check "Auto" if you want the standard to be detected automatically).
- 4** Press on "Start measuring".
- 5** When finish press on "Name" box to edit the channel plan name. Press on "Save channel plan" to save changes or "Cancel" to exit without saving.



► **Create a new Channel Plan**



Figure 33.

- 1** Press on box "Name" to give a name to the new channel plan.
- 2** At the next screen, press on "Add Channel", "Remove Channel" to edit channel plan. When finish, press on "Save channel plan" to save changes or "Cancel" to exit without saving.

4.2 Demodulator

► **Description**

Demodulator provides the most important measurements technicians need to assess digital QAM channel quality. Constellation diagram is a simple and graphical way to identify signal impairments which impact MER and ultimately BER. An ideal QAM channel for example will be represented by a set (constellation) of very sharp dots. These dots will become small dot clouds to indicate the presence of noise or other signal degradation sources. In addition to constellation diagram it also measures MER, preBER and postBER simultaneously with the spectrum trace.



► **Operation**

DEMODULATOR is available for digital signals of functions **SPECTRUM ANALYZER** and **SCAN**.

- 1 Select channel or frequency and tune it.
- 2 Press on "System" option.

► **Screen Description**

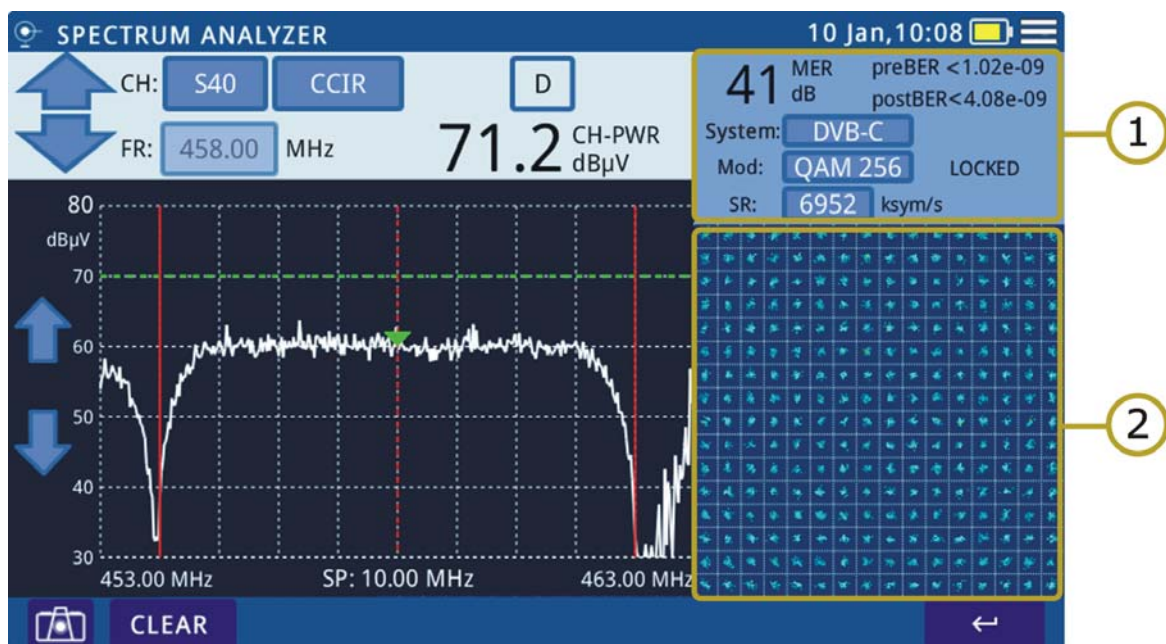



Figure 34.

- 1 Demodulated Signal Data.
 - MER for tuned channel.
 - pre-BER (BER before correction).
 - post-BER (BER after correction).
 - Transmission standard. Press to switch.
 - Modulation type. Press to switch.
 - Signal status LOCKED / UNLOCKED.
 - Symbol rate. Press to switch.
- 2 Constellation Diagram (I-Q diagram).



► Options Menu

There are some options at the bottom of the screen:

- **CLR IQ:** It clears constellation.
-  Back to previous screen.

4.3 **Analog Video Carrier / HUM**

► Description

The equipment can measure video carrier signal level, audio carrier signal level (for PAL, SECAM or NTSC standard), Video/Audio ratio, C/N ratio and **HUM** in analog mode. This is all shown alongside the screen together with the spectrum analyzer graphic.

The **HUM** is buzz at low frequency modulation that affects video analogue carriers, producing a distinctive hum. The **HUM** value up to 2% is considered acceptable. Above this value is not acceptable and it should take appropriate countermeasures.

► Operation

HUM is available for analogue signals in these functions: **SPECTRUM ANALYZER** and **SCAN**.

- 1** Select channel or frequency and tune it.
- 2** Press on "System" option.



► **Screen Description**

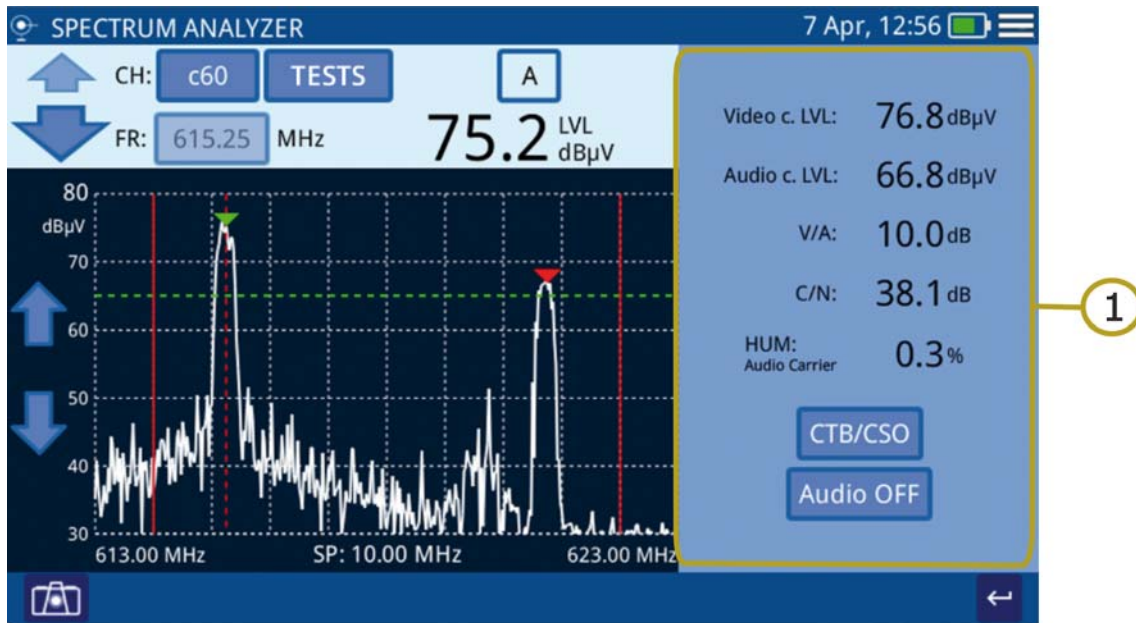

Figure 35.

- 1** Analogue Video Carrier / HUM.
- Video c.LVL: Level of video carrier.
 - Audio c.LVL: Level of audio carrier.
 - V/A: Video/Audio ratio.
 - C/N: Carrier/Noise ratio.
 - HUM: Audio carrier.
 - CTB/CSO: Intermodulation product measurement.
 - Audio OFF/ON: It enables / disables audio and to set audio level.

4.4 Screenshot

► **Description**

It saves a screenshot of current screen that can be downloaded to a USB flashdrive.



► Operation

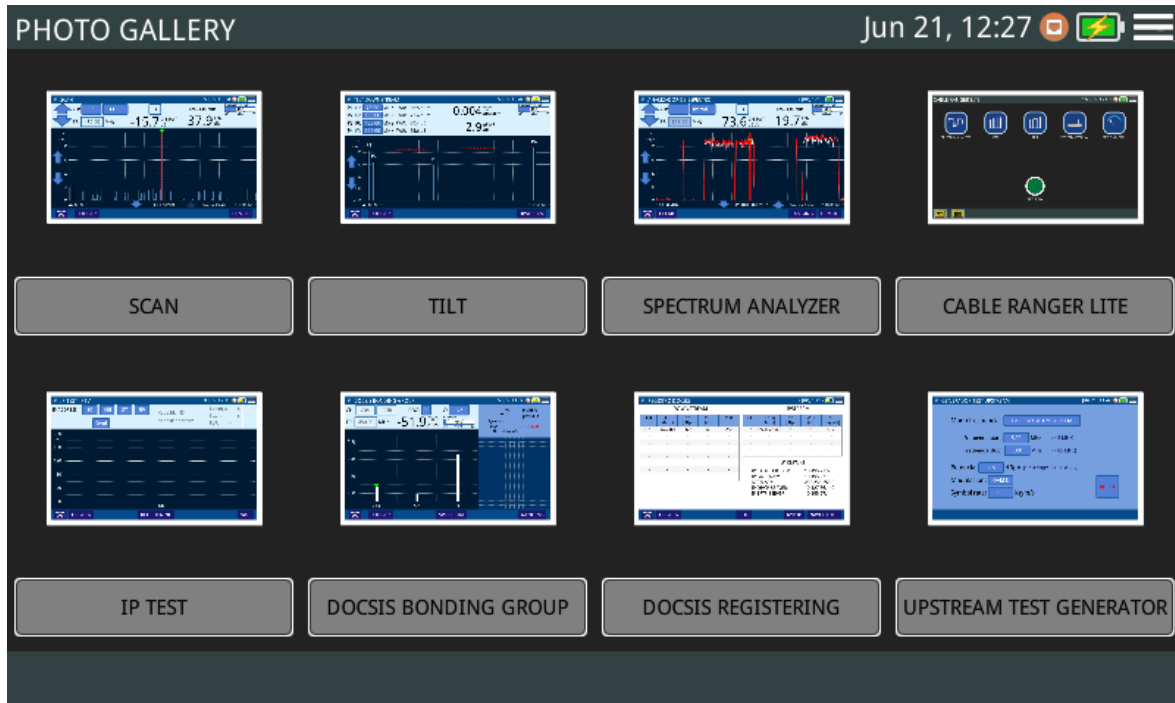



Figure 36.

Screenshot is available almost all functions.

- 1 To take a screenshot press on photo camera icon  at the lower left corner.
- 2 It pops up a window with a screenshot miniature and some options: "Save and close", "Save and go to gallery" and "Cancel". Press your option.
- 3 To access the photo gallery with all the screenshots, from home screen press on icon  at the lower left corner.
- 4 Inside Photo Gallery, screenshots are classified by function.
- 5 Press on the corresponding folder and then on the image to view the screenshot.
- 6 To copy screenshots connect a USB flashdrive on USB port and press on menu option  and the on "Save in USB".
- 7 To remove a folder, go to the Photo Gallery, press on option menu  and then on "Remove". Now select the folder to remove and confirm.



- 8 To remove a single screenshot, see the screenshot fullscreen, press on option menu  and then on "Remove" and confirm.

4.5 Datalogger

► Description

Datalogger function can logger automatically several measurements depending on the selected function, including signal level and channel power, carrier/noise, BER and MER for all channels in a specific channel band.



[SCAN Datalogger and TILT](#)

SCAN



► Operation



Figure 37.

- 1 To start datalogger, press on DATALOGGER at the left lower corner inside the tool. You can also press on "Test & Go" green button at the home screen.
- 2 A window opens with several setting options. You can edit boxes with colour background (name, location, threshold...) when pressing on it. Check the box to select measurements and press on "Start Measuring" or "Cancel".



- 3 It starts datalogger.
- 4 After finish, press on "Save and close", "Save and go to datalogger" or "Cancel".
- 5 To access datalogger, go to home screen and press on  icon at the lower left corner.
- 6 Datalogger are classified by function.
- 7 Press on any folder, then press on the datalogger to see data.
- 8 To remove a folder with dataloggers or a single datalogger, press on the menu option  and then on "Remove". It shows a window where to select a folder or datalogger to remove. Select and accept.
- 9 To copy a folder with dataloggers or a single datalogger to a USB memory in first place insert a USB memory in the USB slot. Press on menu option  and then press on "Save on USB". It shows a window with the path where are the files to be copied. Confirm to save.



5 WEBCONTROL

5.1 Introduction

The webControl function allows you to connect remotely to the meter in order to visualize measurements and operate on it. The meter must be connected to an Ethernet network. To connect to meter from a remote access device use just a standard web browser.

Next section explains how to configure the meter to be able to connect remotely. Following sections explain each work mode.

5.2 Settings and Remote Access

► Meter Settings

- 1** The meter can be connected to a data network via an Ethernet cable. To access the configuration parameters. Press on the MENU icon  at the upper right corner to access the settings menu.
- 2** Press on the option "Ethernet configuration" to access parameters to set Ethernet network. They are: Connection type (manual, DHCP, Bridge), IP, mask, gateway, DNS 1 and DNS 2.
- 3** If you connect the meter to a network with a router or server with DHCP or Bridge protocol enabled, then the network will set automatically the parameters in the meter. If not, follow the next steps to set the meter.
- 4** On "IP Address" box enter the meter IP. Use an IP in the same range used by your PC in the local network. For instance, if the IP for your PC is 10.0.1.18, the meter must have a free IP in the same range, like 10.0.1.50.
- 5** In the "Mask" box, enter the mask value, which should be the same as the one used by the local network (usually 255.255.255.0; if you do not know these data see "find out local network data" section).
- 6** To connect the meter from an external network, fill in the "Gateway" with the info obtained from the local network. You can use the default data for DNS 1 and DNS 2 or use other values.
- 7** Press on OK to save data and re-start the meter to apply changes.
- 8** Connect the meter to a data network with Internet access. You can use an Ethernet cable connected to the ETH port.



► Remote Access

- 1 From a PC run a standard web browser (Chrome recommended).
- 2 On the address bar write the address to remotely access the meter.
- 3 If the connection is successful, it should appear on screen the webControl welcome screen (see figure). This screen shows the meter model and serial number.

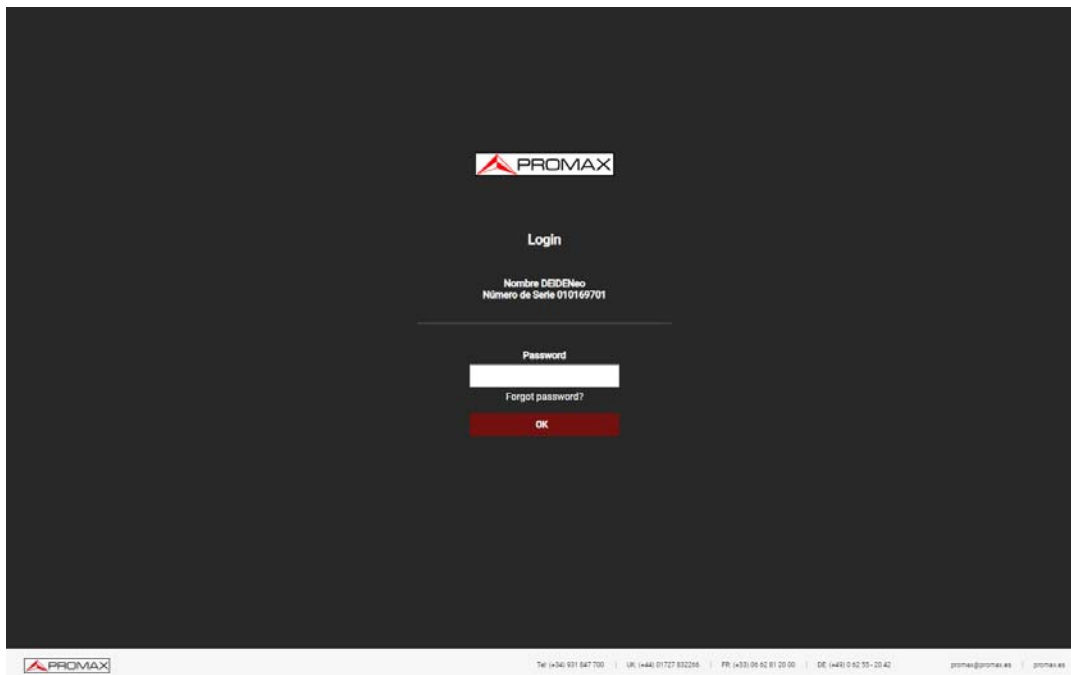

Figure 38.

- 4 Enter the password and press OK (password by default is **Password**).

NOTE: If you have follow these instructions and you fail to connect the webControl, please contact PROMAX technical assistance and we will help you (promax@promax.es).

► Password Recovery

If after changing the webControl password you forget it, click on "forgot password?". It opens a window with some instructions to reset the password. Follow these steps:

A one-time temporary password will be emailed to you, so that you can log in and modify your password.

- 1 Send an e-mail to the PROMAX technical assistance service (promax@promax.es) with the following information:



- Contact details: Full name, company name and address, phone number and e-mail.
 - Internal number shown on the window.
 - Recovery code shown on the window.
- 2 Once this information is sent, it is checked and if everything is right, a temporary password is sent back. Write this password on the box "temporary password". This password is for one time use.
 - 3 If you have access to the main screen go to "Config" on the upper right corner and click on "Change Password".
 - 4 A window will appear to change the password. Enter the temporary password in the "Old password" box. Enter your new password in the "New password" box and again in the "Repeat new password" box. Press OK.

5.3 File Management

► Description

Installations Management allows you to access the File Manager and the Create Channel Plan tool.

At the top of the screen there is some data about the meter connected (model name, serial number, release/webControl version) and some user settings: Change password, reboot equipment and logout.

To access this screen press on .

5.3.1 File Manager

This function allows you to manage files inside an installation (channel plans, screenshots, etc.).







► File Manager Operation

- 1 Press on tab "File Manager" to access the file manager. Wait for few seconds to system to read all files from the meter.
- 2 All files and folders are shown on the left side of the window. The "ChannelPlans" folder contains channel plans. The "Screenshots" folder contains screenshots. When clicking on a folder it deploys its content in a tree structure. The area on the right side shows the content inside the selected folder.









- 3 The padlock icon on an item means that it cannot be removed. If the padlock is on a folder it also means that its content cannot be change (nor deleted or added).
- 4 To make any action on an item use the tools bar or deploy the options menu by pressing the right button of the mouse. Next are described the most common options.





► Tools Bar:

-  Back: Back to the previous screen.
-  Forward: Back to the posterior screen.
-  Upload: It transfers a document from your PC to the meter. It shows a window where you can drag files, paste URLs or images or select files or folders from your PC.
-  Open: It opens a folder or downloads the selected file.
-  Download: It downloads a folder or file to your PC. When it is a folder or multiple files, it downloads a zipped file in TGZ format.
-  Delete: It deletes the folder or file selected.

► Options Menu (mouse right button):

-  Open: It opens a folder or downloads the selected file.
-  Download: It downloads a folder or file to your PC. When it is a folder or multiple files, it downloads a zipped file in TGZ format.
-  Preview: It shows file info.
-  Upload files: It transfers a document from your PC to the meter. It shows a window where you can drag files, paste URLs or images or select files or folders from your PC.
-  Delete: It deletes the folder or file selected.
-  Edit Channel Plan: It allows editing a channel of the equipment. It only works if a channel plan file (XML extension) is selected. The channel plan files are located in the CH folder (for more details see the next section).
-  Empty the folders: It removes all the content inside a folder.



-  Create archive: It creates a zip file from the files selected in TAR or GZIP format.
-  Extract files from archive: It unzips a zipped file in a new folder or in the current folder.
-  Select All: It selects all the files.
-  Invert selection: It reverts the current selection.
-  Get info: It shows some info about the selected file.

► **File and Installations Management Screen**

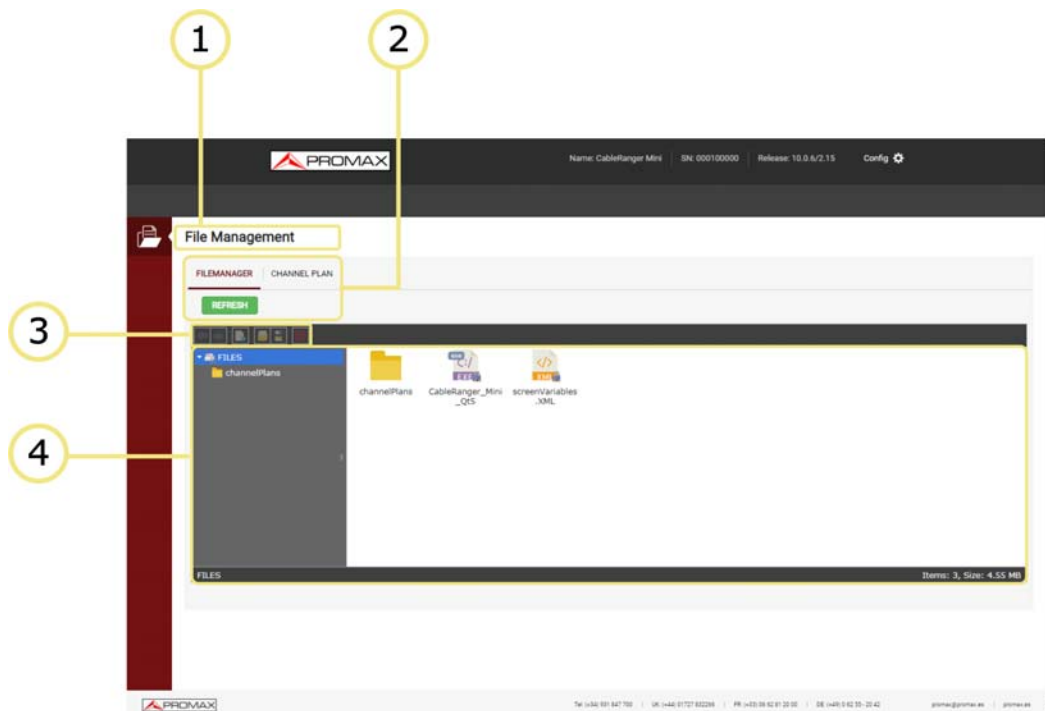

Figure 39. File Manager

- 1 Selected function (Installations Management).
- 2 Tabs to select the File Manager or the Channel Plan Creator.
- 3 Toolbar.
- 4 File navigation area.

5.3.2 Channel Plan Creator

This functions allows you to create a channel plan from scratch.



► Channel Plan Creator Operation

- 1 Press on the "Channel Plan" tab to access the channel plan creator. Press on "Create Channel Plan" button.
- 2 In the box "Name" enter the channel plan name.
- 3 Press the "Add Channel" button and enter one by one each channel that made the channel plan. Enter channel name, frequency and signal type for each channel.
- 4 Edit each parameter by clicking on it.
- 5 Once finished press on "Download Channel Plan" to download it on your PC. By default the channel plan file is downloaded inside the folder "Downloads" in your PC. The file has XML format.
- 6 To use the new channel plan, upload the XML file by means of the File Manager with the option "Upload files". Upload it to the "ChannelPlans" folder. The channel plan should be now available to use it on the meter.

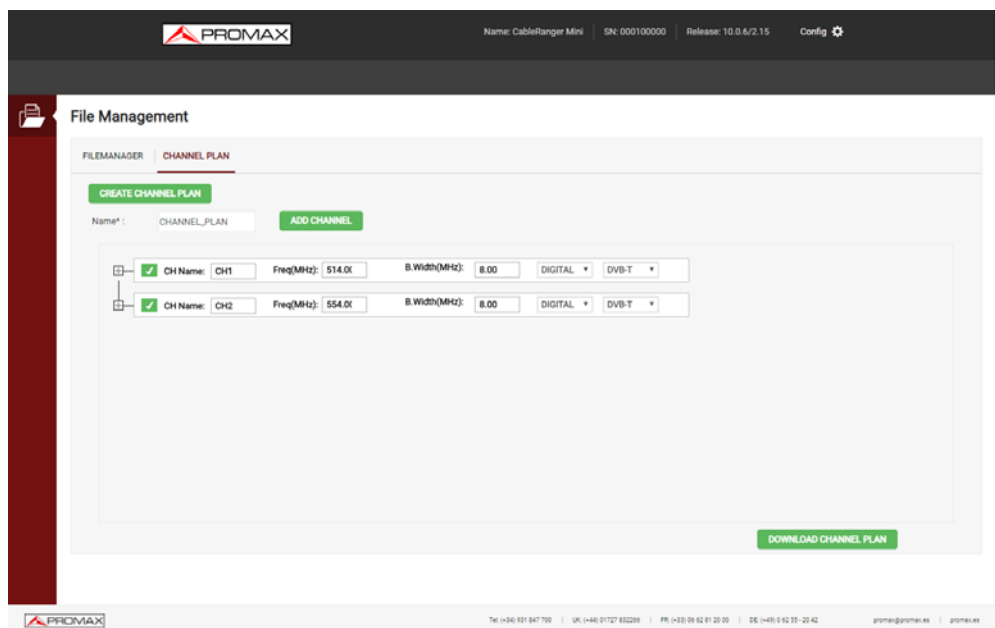

Figure 40. Channel Creation

5.3.3 Channel Plan Editor

This function allows you to edit channel plans.



► Channel Plan Editor Operation

- 1** Files with channel plans are inside the "ChannelPlans" folder. Select the file that contains the channel plan to edit and press the right button on the mouse to select the "Edit channel plan" option.
- 2** The channel plan definition parameters and all the channels that form it will appear. From here you can edit any value by clicking on the box.
- 3** Channels can be modified by clicking on each parameter.
- 4** Once the channel plan is finished, click on "Download Channel Plan" to download it to the PC. By default the file with the channel plan is downloaded in the PC "Download" folder. The file is in XML format.
- 5** To use the channel plan, upload the XML file by means of the File Manager with the option "Upload files". Upload it to the "ChannelPlans" folder. The channel plan should be now available to use it on the meter.



6 SPECIFICATIONS

6.1 Spectrum Analyzer

► Frequency

Parameter	Value	Additional Data
Tuning Range	From 5 to 2700 MHz	
Tuning Mode	By Frequency or by channel	
Bandwidth resolution	230 kHz, 2 MHz	
Frequency step	10 KHz	
Accuracy	20 ppm	
Sweep time	600 ms full band	
Span	10 MHz	Full band

► Amplitude

Parameter	Value	Additional Data
Dynamic range	-50 dBmV to 60 dBmV	
Screen range	50 dB	
Max Input level	70 dBmV	
Resolution	0.1 dB	
Accuracy	± 2 dB	
Input impedance	75 Ohms	
Units	dBmV, dBuV, dBm	

► Measurements: Frequency tuning mode

Parameter	Value	Additional Data
Level	- 50 dBmV to 60 dBmV	Peak detector level measurement from marker
Audio demodulation	Analog FM	
C/N	>50 dB for level >10 dBmV	Selectable noise frequency marker
HUM	1-15 % , ± 1 % accuracy	For CW carriers

► Measurements: Digital Channel tuning mode

Parameter	Value	Additional Data
Tuning Range	10 - 2700 MHz	950 - 2150 MHz (satellite)
Standards	DVB-C, DVB-C2, DVB-S, DVB-S2, DVB-T, QAM Annex A/B/C, ISDB-T, J.382	
Measurements	BER, MER, Power, Constellation	
Power	From -40 dBmV to 60 dBmV	Power measurement in the channel bandwidth by integration method



► **Digital Channel Demodulation**

Parameter	Value	Additional Data
SR	1000-7000 ksym/s	
MER	From 24 dB to 43 dB for QAM16,32,64,128,256 and QPSK	Accuracy ± 2 dB
BER	Pre BER (Before RS): From 10 E-2 to 10 E-10	Post BER (After FEC): From 10 E-2 to 10 E-10
Constellation Diagram	For all systems with x2, x4 zoom	
Lock range	-20 dBmV to 60 dBmV	

► **Measurements: Analog Channel**

Parameter	Value	Additional Data
Tuning Range	From 10 to 2700 MHz	
Measurements	Level, C/N, CTB-CSO, HUM	
Sound demodulation	FM	
Video Carrier Signal Level	From -45 dBmV to 60 dBmV	

► **Analog Channel Demodulation**

Parameter	Value	Additional Data
Audio Carrier signal level, A/V	0- 30 dB	For PAL, SECAM or NTSC standard
C/N	48 dB for input level > 10 dBmV	
HUM (over audio carrier)	1-15%, 1% accuracy	
CTB/CSO	60 dB dynamic range. (In channel with removed carrier or out of channel selecting a not used channel)	± 3 dB accuracy
Sound	Broadcast FM demodulation from internal speaker	

► **Measurements: Satellite Channel**

Parámetro	Valor	Datos Adicionales
Tuning Range	950 - 2150 MHz	
Measurements	BER, MER, Power, Constellation	DVB-S, DVB-S2
LNB Power supply	13 V / 18 V	

► **Configuration Menu**

Parameter	Value	Additional Data
Channel Plan	Yes	
Standard TV Channel plans	CCIR,EIA,HRC,IRC,OIRL,FCC up to 10	
Customized Channel plan	Up to 30	
Units	dBmV, dBuV, dBm	
Reference Line	from -60 dBmV to 120 dBmV	
Trace	normal, max hold and min hold	
Frequency step	from 10 kHz to 100 MHz	
Top Frequency	900 MHz, 2700 MHz or selectable	



6.2 Scan

► Frequency

Parameter	Value	Additional Data
Tuning Range	Full frequency band occupied by selected Channel plan	
Tuning Mode	by channel	
Bandwidth resolution	230 kHz	

► Amplitude

Parameter	Value	Additional Data
Dynamic range	-50 dBmV to 60 dBmV	
Screen range	50 dB	
Max Input level	70 dBmV	
Resolution	0.1 dB	
Accuracy	± 2 dB	
Input impedance	75 Ohms	
Units	dBmV, dBuV, dBm	

► Measurements: Digital Channel

Parameter	Value	Additional Data
Power	From -40 dBmV to 60 dBmV	Power measurement in the channel bandwidth by integration method at the marker. Represented by vertical blue bars

► Channel Demodulation

Parameter	Value	Additional Data
QAM Systems compatibility	DVB-C, ITUJ83 Annex B and C	
SR	1000-7000 ksym/s	
MER	From 24 dB to 43 dB for QAM16, 32, 64, 128, 256 and QPSK	Accuracy ± 2 dB
BER	Pre BER (Before RS): From 10 E-2 to 10 E-10	Post BER (After FEC): From 10 E-2 to 10 E-10
Constellation Diagram	For all systems with x2, x4 zoom	
Lock range	-20 dBmV to 60 dBmV	

► Measurements: Analog TV Channel

Parameter	Value	Additional Data
Video Carrier Signal Level	From -45 dBmV to 60 dBmV	Represented by vertical white bars



► **Channel Demodulation**

Parameter	Value	Additional Data
Audio Carrier signal level, A/V	0- 30 dB (for PAL, SECAM or NTSC standard)	
C/N	48 dB for input level > 10 dBmV	
HUM (over audio carrier)	1-15%, 1% accuracy	
CTB/CSO	60 dB dynamic range. (In channel with removed carrier or out of channel selecting a not used channel)	± 3 dB accuracy
Sound	Broadcast FM demodulation from internal speaker	

► **Configuration Menu**

Parameter	Value	Additional Data
Channel Plan	Yes	
Standard TV Channel plans	CCIR,EIA,HRC,IRC,OIRL,FCC up to 10	
Customized Channel plan	Up to 30	
Units	dBmV, dBuV, dBm	
Reference Line	from -60 dBmV to 120 dBmV	
Units	dBmV, dBuV, dBm	
Reference Line	from -60 dBmV to 120 dBmV	
Thresholds	Max and Min limits for quality evaluation	

6.3 **Tilt**

► **Downstream**

Parameter	Value	Additional Data
Frequency:	Four selectable tuning frequencies (pilots) from 45 MHz to 2700 MHz	
Bandwidth resolution	230 kHz	
Tuning resolution:	10 kHz	
Dynamic range:	-50 dBmV to 60 dBmV	
Screen range:	50 dB	
Max Input level:	70 dBmV	
Resolution:	0.1 dB	
Measurements:	Level of four selected frequencies	±0 to 30 dB/ MHz (Tilt) between two selected pilots
Resolution:	0.1 dB	

► **Upstream**

Parameter	Value	Additional Data
Frequency	Four selectable tuning frequencies (pilots) from 45 MHz to 2700 MHz	



Parameter	Value	Additional Data
Bandwidth resolution	230 kHz	
Tuning resolution	10 kHz	
Dynamic range	-50 dBmV to 60 dBmV	
Screen range	50 dB	
Max Input level	70 dBmV	
Resolution	0.1 dB	
Measurements	Level of four selected frequencies	±0 to 30 dB/ MHz (Tilt) between two selected pilots
Resolution	0.1 dB	

► Configuration Menu

Parameter	Value	Additional Data
Units	dBmV, dBuV, dBm	
Select two pilots for Tilt	P_bottom / P_top	

6.4 DOCSIS Analyzer

► Frequency

Parameter	Value	Additional Data
Tuning Range Downstream CABLE RANGER 3.0	From 108 to 1002 MHz	
Tuning Range Downstream CABLE RANGER 3.1	From 108 to 1219 MHz	
Tuning Range Upstream CABLE RANGER 3.0	From 5 to 85 MHz	
Tuning Range Upstream CABLE RANGER 3.1	From 5 to 200 MHz	
Tuning Mode Upstream	By Frequency or by channel	
Frequency step	10 KHz	
Bandwidth resolution	230 kHz, 2 MHz	
Accuracy	20 ppm	
Sweep time	600 ms full band	

► Amplitude

Parameter	Value	Additional Data
Dynamic range	-50 dBmV to 60 dBmV	
Screen range	50 dB	
Max Input level	70 dBmV	
Resolution	0.1 dB	
Accuracy	± 2 dB	
Input impedance	75 Ohms	
Units	dBmV, dBuV, dBm	



► **Measurements: Frequency tuning mode**

Parameter	Value	Additional Data
Level	- 50 dBmV to 60 dBmV	Peak detector level measurement from marker
Audio demodulation	Analog FM	
C/N	Selectable noise frequency marker	
HUM	1-15 % , ± 1 % accuracy	For CW signals

► **Measurements: Digital Channel tuning mode or DBG carrier mode**

Parameter	Value	Additional Data
Power	From -40 dBmV to 60 dBmV	Power measurement in the channel bandwidth by integration method

► **Downstream DOCSIS Channel Demodulation**

Parameter	Value	Additional Data
Built-in Cable Modem CABLE RANGER 3.0	DOCSIS 3.0	Compatible with DOCSIS 2.0
Built-in Cable Modem CABLE RANGER 3.1	DOCSIS 3.1	Compatible with DOCSIS 3.0, DOCSIS 2.0
MER	From 27 dB to 40 dB	
BER	Pre BER (Before RS): From 10 E-2 to 10 E-10	Post BER (After FEC): From 10 E-2 to 10 E-10
Constellation Diagram	For all systems with x2, x4 zoom	
Lock range	-20 dBmV to 60 dBmV	

► **Others**

Parameter	Value	Additional Data
DOCSIS BONDING GROUP (DBG) CABLE RANGER 3.0	8 QAM + 2 OFDM	1-8 graphic bar channels representation
DOCSIS BONDING GROUP (DBG) CABLE RANGER 3.1	32 QAM + 2 OFDM	1-8 graphic bar channels representation
RANGING PROCESS	DOWNSTREAM/UPSTREAM CABLE MODEM measurements to fix Upstream power and Frequency	
REGISTERING PROCESS	8 Downstream channels x 4 upstream channel table representation	Full IP address
IPTV, VOIP test	Packet transmission for PLR, lattency, jitter Rvalue and MOS	

► **Configuration Menu()**

Parameter	Value	Additional Data
Channel Plan	Yes	
Standard TV Channel plans	CCIR,EIA,HRC,IRC,OIRL,FCC up to 10	
Customized Channel plan	Up to 30	
Units	dBmV, dBuV, dBm	
Reference Line	from -60 dBmV to 120 dBmV	
Trace	normal, max hold and min hold	



Parameter	Value	Additional Data
Frequency Step	from 10 kHz to 100 MHz	
Top Frequency	900 MHz, 2700 MHz or selectable	

6.5 Upstream Generator

► Frequency

Parameter	Value	Additional Data
Mode CABLE RANGER 3.0	QAM	
Mode CABLE RANGER 3.1	QAM / OFDM 4K	
Tuning range CABLE RANGER 3.0	From 5 to 85 MHz	
Tuning range CABLE RANGER 3.1	From 5 to 204 MHz	
Dual mode	Fix frequency or sweep	
Resolution	100 kHz	
Accuracy	±5 kHz	
Carrier level CABLE RANGER 3.0	from 60 to 115 dBuV (1 dB step)	
Carrier level CABLE RANGER 3.1	from 50 to 120 dBuV (1 dB step)	
Level accuracy	±3 dB	
Modulation	QPSK, 16QAM, 32QAM, 64QAM	
SR	From 160 ksym/s to 5120 ksym/s	

► Configuration Menu

Parameter	Value	Additional Data
Units	dBmV, dBuV, dBm	
CM information	SW MODEM, MAC ADDRESS	

6.6 External Cable Modem / Upstream Spectrum

► Frequency

Parameter	Value	Additional Data
Tuning Range CABLE RANGER 3.0	From 5 to 85 MHz	
Tuning Range CABLE RANGER 3.1	From 5 to 200 MHz	
Tuning mode	By frequency	
Bandwidth resolution	230 kHz, 2 MHz	
Accuracy	20 ppm	



► **Amplitude**

Parameter	Value	Datos Adicionales
Dynamic range	-50 dBmV to 60 dBmV	
Screen range	50 dB	
Max Input level	70 dBmV	
Resolution	0,1 dB	
Accuracy	± 2 dB	
Input impedance	75 Ohms	
Units	dBmV, dBuV, dBm	

► **Settings**

Parameter	Value	Datos Adicionales
Trace	Max hold and min hold	
Upstream band	Docsis 2.0 upstream band/ Docsis 3.0 upstream band	
Channel bandwidth	CW, 5 MHz, 7 MHz or selectable	

6.7 Input Voltage and RF Power Meter

► **RF Power Measurement**

Parameter	Value	Additional Data
Frequency band	5-2700 MHz	
Power accuracy:	± 3 dB	

► **Input Voltage Measurement**

Parameter	Value	Additional Data
VDC	1-90 V	
VAC	1-30 V,	
Frequency measurements	From 10 Hz to 200 Hz,	±2 % accuracy

► **Configuration Menu**

Parameter	Value	Additional Data
Units	dBmV, dBuV, dBm	



6.8 Optical Measurement

► Optical Power Meter

Parameter	Value	Additional Data
Optical Band	1100 nm – 1700 nm	
Connector	SC-APC	
Dynamic range	- 50dBm to 10 dBm (0.5 dB accuracy)	
Calibrated wavelength	1310, 1490, 1550 nm	

► Optical to RF Converter

Parameter	Value	Additional Data
Optical band	1100 nm – 1700 nm (Optical band pass filter as especial option)	
RF band	45 MHz to 2700 MHz	
Dynamic range	-15 dBm to 10 dBm	
Operation	RF from optics internally redirect TO SPECTRUM ANALYZER and DOWNSTREAM DOCSIS analyzer	

6.9 General Specifications

► Inputs and Outputs

Parameter	Value	Additional Data
Coax 1	Yes	F type
Coax 2	Yes	F type
Optical	Yes	SC-APC
USB 1	Yes	USB
USB 2	Yes	Mini-USB
Ethernet	Yes	
VDC	Yes	AC-DC From 5 to 1000 V
Touch Monitor Display	Yes	

► Mechanical Features

Parameter	Value	Additional Data
Dimensions	290 x 185 x 85	
Weight	1.6 kg	

► Power Supply

Parameter	Value	Additional Data
Internal battery	7,2 V; 6,6 Ah Li-Ion	



Parameter	Value	Additional Data
Battery Operation Time	> 2 hours in continuous mode	
Recharging Time	3 hours up to 80% turned off	
External Voltage	12 V DC	
Consumption	40 W	
Auto Power Off	No	

► **Operating Environmental Conditions**

Parameter	Value	Additional Data
Altitude	Up to 2.000 m	
Temperature range	From 5°C to 40°C	
Max. Relative Humidity	80 %	up to 31°C, decreasing lineally up to 50% at 40°C

NOTE: Equipment specifications are set in these environmental operating conditions. Operation outside these specifications are also possible. Please check with us if you have specific requirements.

► **Included Accesories**

Parameter	Value	Additional Data
	DC Adapter + power cable, input adapter (F/h to F/h), carrying case, suitcase, Quick reference guide	



7 MAINTENANCE

7.1 Instructions for Returning by Mail

Instruments returned for repair or calibration, either within or out of the warranty period, should be sent with the following information: Name of the Company, name of the contact person, address, telephone number, receipt (in the case of coverage under warranty) and a description of the problem or the service required.

7.2 Considerations about the TFT Screen

This paragraph offers key considerations regarding the use of the colour screen, taken from the specifications of the manufacturer.

In the TFT screen, the user may find pixels that do not light up or pixels that are permanently lit. This should not be regarded as a defect in the TFT. In accordance with the manufacturer quality standard, 9 pixels with these characteristics are considered admissible.

Pixels which are not detected when the distance from the surface of the TFT screen to the human eye is greater than 35 cm, with a viewing angle of 90° between the eye and the screen should not be considered manufacturing defects either.

It is advisable a viewing angle of 15° in the 6.00 o'clock direction in order to obtain the optimum visualization of the screen.

7.3 Cleaning Recommendations

The equipment consists of a plastic case and a TFT screen. Each element has its specific cleaning treatment.

► Cleaning the TFT Screen

The TFT screen surface is VERY DELICATE. It has to be cleaned with a soft fabric cloth (cotton or silk), always making the same move from left to right and from top to bottom, without putting pressure on the screen.

The TFT screen has to be dry-cleaned or with a product specifically designed for TFT screens, by slightly dampening the cloth. NEVER use tap or mineral water, alcohol or conventional cleaning products, because they contain components that can damage the screen.

Turn off the equipment to locate dirt on the screen. After cleaning, wait a few seconds before turning on.



► **Cleaning the Plastic Case**

The equipment has to be disconnected before cleaning the case.

The case must be cleaned with a solution of neutral soap and water, using a soft cloth dampened with this solution.

Before use, the equipment has to be completely dry.

Never clean with abrasive soaps, chlorinated solvents or aromatic hydrocarbons. These products may degrade the case.





PROMAX TEST & MEASUREMENT, S.L.U.

Francesc Moragas, 71
08907 L'Hospitalet de Llobregat (Barcelona)
Spain

Phone: 93 184 77 00 - International: (+34) 93 184 77 02
e-mail: promax@promaxelectronics.com

www.promaxelectronics.com